

JANUARY, 1928

25 CENTS

RADIO

(REG. U. S. PATENT OFF.)

3.50



**IN THIS
ISSUE**

**— GERALD BEST'S 115 KILOCYCLE SUPER
FOR SHIELDED GRID TUBE OPERATION
HAMMARLUND—ROBERTS SHIELDED GRID TUBE HI-Q**

Cunningham RADIO TUBES

SINCE 1915

STANDARD FOR ALL SETS



Gifts

that bring happiness at
Christmas time and
throughout the year

Radio sets and radio equipment make immensely popular Christmas gifts.

To assure the utmost in Yule-tide Radio enchantment, see that Cunningham Radio Tubes are on duty in every socket. Every owner of a radio will be delighted to receive a set of new tubes.

Buy them in combination of five or more. Your dealer will tell you the correct types of Cunningham Radio Tubes for which any radio is designed.

*Don't use old tubes with new ones.
Use new tubes throughout*

E. T. CUNNINGHAM, Inc.
NEW YORK CHICAGO
SAN FRANCISCO



DEPENDABILITY, convenience and long life are three of the outstanding advantages of Faradon Capacitors.

When interested in electrostatic condensers for replacement, and also, for kits or a new set, make sure that you get Faradon—the choice of men who know radio.

There is a high grade radio store near you which sells Faradon. Ask for them.

**WIRELESS SPECIALTY
APPARATUS COMPANY**

JAMAICA PLAIN, BOSTON, MASS., U. S. A.

ESTABLISHED 1907

*The
choice of
men who
know*

Faradon

Electrostatic condensers for all purposes

Tell them that you saw it in RADIO

RADIO

With Which Is Incorporated "Radio Journal"
Established 1917

Published Monthly by the Pacific Radio Publishing Co.

ARTHUR H. HALLORAN,
Editor
GERALD M. BEST,
Technical Editor

H. W. DICKOW,
Business Manager
A. I. RIVETT,
Draughtsman

Branch Offices:

New York City, 20 East 42nd St.
Chicago, 307 N. Michigan Ave.
Boston, 86 St. Botolph St.
Kansas City, Mo., Davies & Dil-
lon, 707 Land Bank Bldg.

Rates:

Issued Monthly, 25c a copy.
Subscription price, \$2.50 per year
in the U. S., \$3.00 per year else-
where.

Correct Addresses:

Instructions for change of address
should be sent to the publisher
two weeks before the date they
are to go into effect. Each old
and new address must always be
given.

Advertising:

Advertising Forms Close on the
First of the Month Preceding
Date of Issue.

Member Radio Magazine Publishers' Association
Entered as second-class matter at Post Office at San Francisco, Calif.
Copyright 1927 by the Pacific Radio Publishing Co.

Address all communications to

Pacific Radio Publishing Company

Pacific Building, San Francisco, California

VOLUME X

JANUARY, 1928

NUMBER 1

CONTENTS

	PAGE
RADIOTORIAL COMMENT	17
THE 115 KILOCYCLE SUPERHETERODYNE.....	18
<i>By G. M. Best</i>	
THE TRANSMISSION UNIT	22
<i>By Arthur Hobart</i>	
BETTER LOUDSPEAKERS	23
<i>By Alan Donaldson</i>	
S O S	25
<i>By Armstrong Perry</i>	
HOW TO MAKE A THOMSON GALVANOMETER.....	26
<i>By Samuel G. McMeen</i>	
SHIELDED GRID TUBES IN THE 1928 HiQ.....	27
<i>By Francis Churchill</i>	
THE PERFAM AC-4	29
<i>By Perry S. Graffam</i>	
FEED-THROUGH	32
<i>By Donald K. Lippincott</i>	
THE BROWNING-DRAKE TWO TUBE KIT.....	33
<i>By Glenn H. Browning</i>	
WHAT NEXT?	35
<i>By "Old-Timer"</i>	
AN AUTOMATIC RADIO CONTROL.....	36
<i>By Harry R. Lubcke</i>	
NOTES ON RADIO PROSPECTING.....	37
<i>By J. E. Smith</i>	
HOW TO BUILD THE LYNCH NATIONAL 5.....	39
<i>By A. Henry</i>	
QUERIES AND REPLIES	41
THE COMMERCIAL BRASSPOUNDER	42
<i>By P. S. Lucas</i>	
THE S. S. MALOLO	42
<i>By R. O. Koch</i>	
PACIFIC WEATHER REPORTS	43
<i>By L. O. Doran</i>	
NEON GAS LAMP	43
<i>By L. W. Willis</i>	
THE NEEDS OF COMMERCIAL RADIO.....	43
<i>By L. B. Dustin</i>	
LETTERS TO THE EDITOR.....	44
A FLEXIBLE LOW POWER TRANSMITTER.....	45
<i>By Arthur Martini</i>	
CALLS HEARD	46

Forecast of Contents for February Issue

Such regular subscribers as desire may secure upon request a copy of the index of articles and authors appearing in Vol. IX of RADIO during 1927. As the edition is limited those applying first are most likely to be served. Simply send the request to the publishers and the index will be sent without charge.

The practical application of radio to the needs of commercial aviation is described by Geo. S. Morris. He fully describes the equipment used and the procedure followed at the air mail fields of the Western Air Express, Inc., at Los Angeles, Las Vegas and Salt Lake City.

For the experimenter who is interested in the photoelectric cell there are two helpful articles. One by Samuel G. McMeen, entitled "Playing with the Photoelectric Cell," explains its theory in simple terms and describes its application as a measurer of light intensity, as a counter of moving objects, as a photophone, as a darkness alarm, as a sunshine recorder, and as a picture transmitter. The other by John P. Arnold gives a more technical explanation of its theory and characteristics, together with curves.

How to adapt the 115 kilocycle superheterodyne for use with a power amplifier is described by G. M. Best. He will also present some additional hints on the construction and operation of the set described in this issue.

Clinton Osborne describes various means of protecting vacuum tubes from burn out in factory-built and custom-built sets.

Nelson P. Case presents a good argument for using low mu tubes as radio frequency amplifiers.

B. F. McNamee's article on "Calibrating A Short-Wave Receiver With A Broadcast-Band Oscillator," which was unavoidably omitted from the January issue, is definitely scheduled for publication in the February issue.

The same statement applies to Francis Churchill's long-delayed account of the Capacity Coupled Receiver which was crowded out by his article on shielded grid tubes in a two stage r. f. amplifier in this issue.

The amateur operator will be interested in R. Wm. Tanner's description of a good short-wave phone, as well as in a number of pictures and descriptions of amateur installations.

For the commercial operator Mickey Doran has a complete compilation of details regarding the transmission of weather reports from all stations throughout the North Pacific. This is in addition to the fine material regularly presented by P. S. Lucas in the Commercial Brasspounders Department.

The fiction feature is a good radio story by Paul Oard, entitled "The Steam Transmitter."



A



B



C



D

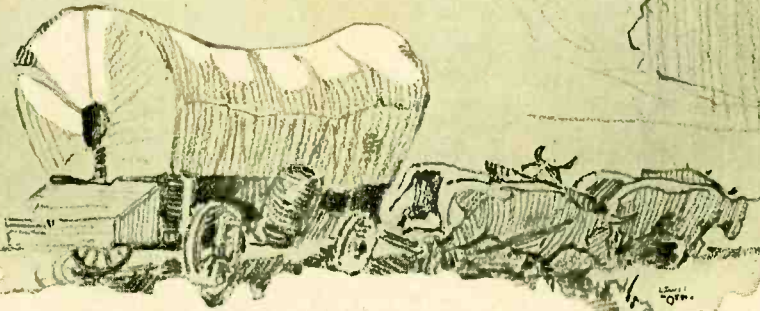

Again REMLER Pioneers

Parts for the New Shielded Tube Circuit

The assured popularity and demonstrated efficiency of the new shield-grid tube circuits bring new set building problems which are completely met by the Remler parts announced for the first time on this page.

The Remler Shielding Case. [A]

A beautifully constructed copper case readily used wherever complete and effective shielding of individual circuits is required. Particularly suited to use in receivers employing the shield-grid tube for which careful shielding is essential. Remler No. 720 Shielding Case Each \$3.00

Remler Interchangeable Inductances. [B]

The Remler Interchangeable Inductance is designed to plug into the standard UX socket and establishes a new standard of convenience. It will cover the broadcast band of 200 to 550 meters when tuned with a condenser of .00035 mfd. capacity and is available in several types. Specifically designed to meet the very definite requirements of the shield-grid tube. Secondary windings of special form to limit external fields. Primary windings readily removable and can be easily modified to give optimum results under any given set of conditions.

Remler No. 550 Interchangeable Inductance—For use as an antenna coupler in conjunction with the Remler No. 502 Antenna Compensator. Each \$3.00

Remler No. 551 Interchangeable Inductance—For use as an antenna coupler without the Remler No. 502 Antenna Compensator. Each \$3.00

Remler No. 560 Interchangeable Inductance—A radio frequency transformer designed to meet the requirements of the shield-grid tube. Each \$3.00

Remler No. 561 Interchangeable Inductance—A radio frequency transformer designed for use with tubes of the CX 301A type. Each \$3.00

Remler Tube Case. [C]

Designed to act as a ballast and to prevent microphonic action in the tube as well as to provide complete shielding of the tube itself. Particularly necessary for the shield-grid tube.

Remler Tube Case No. 54—A die-casting finished in copper and lined with heavy felt. For use with tubes of the CX 299 type. Each \$1.00

Remler Tube Case No. 55—Heavy die-cast base over which fits a formed copper felt-lined shell. Opening provided for the control-grid terminal of the shield-grid tube. For use with the shield-grid tube or a tube of the CX 301A type. Each \$2.00

Remler Tube Case No. 56—Consists of formed copper shell only and is without the heavy, ballasting die-cast base. Each \$1.00

Remler Interchangeable Inductances—Long-Wave Type. [D]

Remler Interchangeable Inductances are enclosed in molded bakelite cases and plug into the standard UX socket. Adjusting screws provided whereby they can be tuned to exactly the frequency required. Designed for use with the shield-grid tube.

Remler Interchangeable Inductance No. 612—A transformer suited to use in the input circuit of a long-wave amplifier. 115KC. Each \$4.00

Remler Interchangeable Inductance No. 614—A tuned impedance intended for interstage coupling in a long-wave amplifier. 115KC. Each \$4.00

Remler No. 570 Oscillator Inductance—Provided with a third winding and extra terminal plate. Will cover band of 180 to 460 meters when tuned with a .00035 mfd. condenser shunted with single balancing condenser furnished with the Inductance. Each \$4.50

Remler Resistance Mounting.

A bakelite strip carrying clips to accommodate a standard grid condenser and grid leak and mounted on brackets so drilled and spaced that they will fit under the mounting screws for the Remler No. 50 Socket. Remler No. 61 Resistance mounting Each \$0.50

REMLER

Division of

GRAY E. DANIELSON Manufacturing Company

CHICAGO

Eastern Warehouse—Elkhart, Indiana

NEW YORK

Tell them that you saw it in RADIO

The Crosley A C Bandbox is the leading radio of today—because

At last! The radio tube that needs no batteries! Here it is functioning quietly, smoothly, powerfully in this new Crosley 6 tube receiver—the A C Bandbox.

Now, the Crosley A C Bandbox needs no more attention than you pay the electric lamp that lights your home.

This is what the world has anticipated and many have imitated. Crosley offers it to you at the **WORLD'S LOWEST PRICE**—\$110 without tubes.

Combined with the Crosley facilities for economical manufacture is the patent situation of which Crosley has full advantage. Licensed to manufacture under the patents controlled by the electrical and radio industries, the Crosley Bandbox is a **NEW** receiver incorporating latest radio developments, the most advanced ideas of radio reception as well as sound reproduction. This outstanding engineering job is best understood when you consider its features are such as are found in radios of twice and more than its price.

- | | |
|---|---|
| 1. Complete shielding of all elements. | 5. Single cable connections. |
| 2. Absolute balance (genuine Neutrodyne). | 6. Single station selector. |
| 3. Volume Control. | 7. Illuminated dial. |
| 4. Acuminators for sharpest tuning. | 8. Adaptability to ANY type installation. |

The set is solidly mounted on a stout steel chassis. As all controls are assembled together in the front, cabinet panels are easily cut to allow their protrusion. The metal escutcheon is screwed on over the shafts and the installation has all the appearance of being built to order.

Two large furniture manufacturers have designed console cabinets in which the Bandbox can be superbly installed (Showers Bros. Co., of Bloomington, Ind., and the Wolf Mfg. Industries of Kokomo, Ind.). Powel Crosley, Jr., has approved them mechanically and acoustically and has seen to it that the famous Crosley Musicones are built in them so that the best type of loud speaker reproduction may be insured.

The Bandbox is housed in a brown frosted crystalline finished metal case which is easily removed for console installation.

See the new Crosley A C Bandbox at your dealer's **NOW!** Hear first hand its delightful performance! Enjoy the best in radio at the least cost! Write Dept. 19 if you can't locate a dealer!

of these wonderful tubes



The amazing new RCA alternanting current tubes—the UX 226 and UY 227—utilize for their filaments and their heating regular house-lighting current. Current is stepped-down through transformers. Rectifiers are *not* used.

the radio patents of these industries



The research and development work of these great industries—The Radio Corporation of America, The General Electric Co., The Westinghouse Co., The American Telephone & Telegraph Co., and The Hazeltine and Latour Corporations—are available to Crosley engineers in the constant advancement of radio design.

and the amazing capacity of this MERSHON Electrolytic CONDENSER



This is one of Crosley's great features. It is an exclusive Crosley device. It is self-healing—will last indefinitely—never needs attention and eliminates the danger of blown out paper condensers which are causing so much trouble in electrically operated sets.

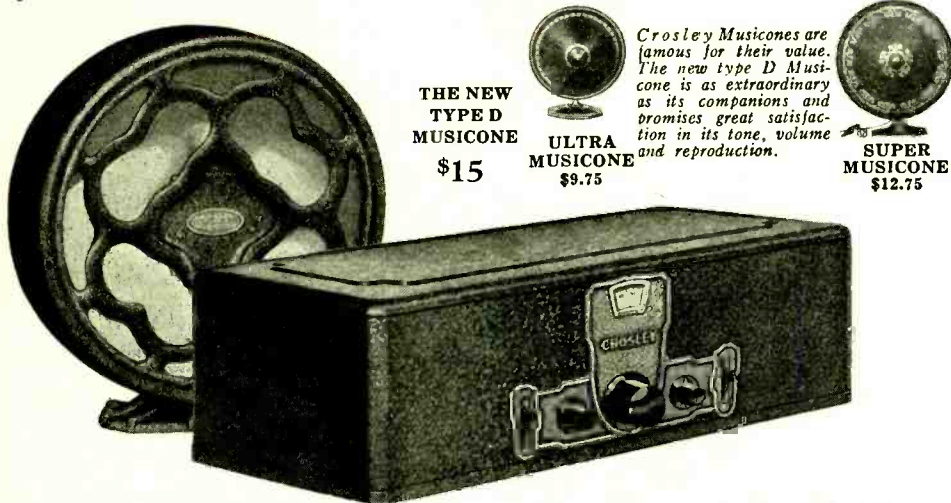

THE NEW TYPE D MUSICONE
\$15



ULTRA MUSICONE
\$9.75

Crosley Musicones are famous for their value. The new type D Musicone is as extraordinary as its companions and promises great satisfaction in its tone, volume and reproduction.



SUPER MUSICONE
\$12.75

CROSLEY RADIO

Crosley is licensed only for Radio Amateur, Experimental and Broadcast Reception.

Montana, Wyoming, Colorado, New Mexico and West, prices slightly higher.

THE CROSLEY RADIO CORPORATION
Powel Crosley, Jr.,
President
Cincinnati, Ohio

Tell them that you saw it in RADIO

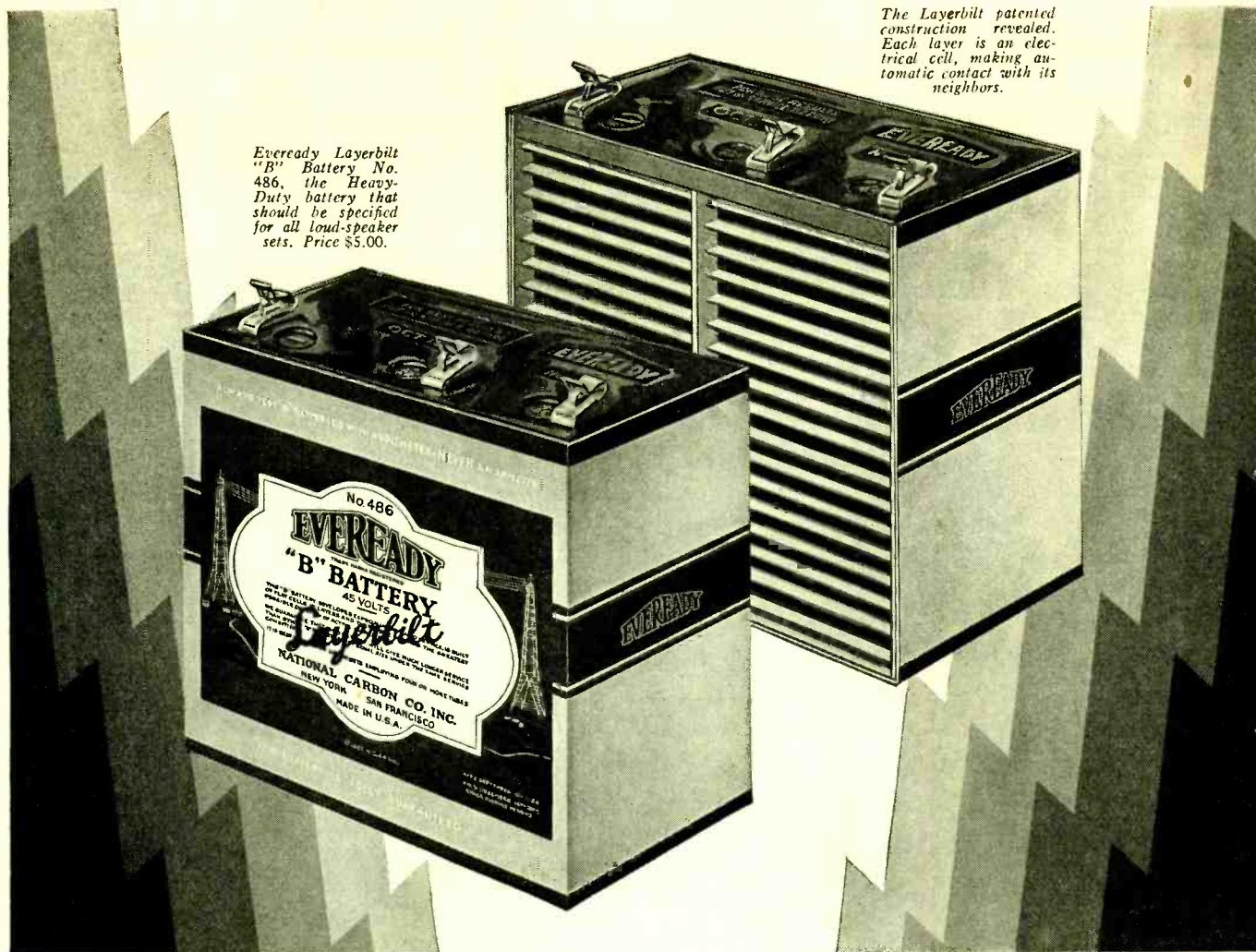

Eveready Layerbilt "B" Battery No. 486, the Heavy-Duty battery that should be specified for all loud-speaker sets. Price \$5.00.

The Layerbilt patented construction revealed. Each layer is an electrical cell, making automatic contact with its neighbors.

Radio is better with *battery* power

RADIO receivers designed for quality reproduction operate best on well-made dry cell "B" batteries. What your ear tells you about the performance of battery-run sets is confirmed by laboratory tests that reveal that batteries alone provide steady, noiseless "B" current, taking nothing from and adding nothing to radio reception. Batteries, and batteries alone, provide pure DC (pure Direct Current). Only such current can give you the best results of which your set is capable.

Battery Power is dependable, convenient, and reliable, under your sole control, ever ready to serve you when you turn on your set. As your "B"

batteries approach the end of their usefulness, a slight drop in volume warns you in ample time. You need never miss a single concert if your set is battery-equipped.

Not only in results, convenience and reliability are "B" batteries unequalled, but they are also unapproached in economy, provided, of course, the correct size batteries are used. That means the Heavy-Duty type for all receivers operating loud speakers, as most do nowadays. Smaller batteries are not as economical, though they give you the quality advantages of Battery Power.

For best economy, choose the Eveready Layerbilt "B"

Battery No. 486. In every test and trial this has proved conclusively to be the longest-lasting "B" battery ever built. Its unique, patented internal construction is responsible for its astonishingly long life. It is, we believe, the most economical, as well as the most satisfactory, convenient and reliable source of "B" current available. Just remember this: Radio is better with *Battery* Power, and the extraordinary Eveready Layerbilt "B" Battery No. 486 offers you that power most economically.

NATIONAL CARBON CO., Inc.
New York San Francisco

Unit of Union Carbide and Carbon Corporation

Shieldplate ^{Type S.P.} 122 ^{Shielded Grid} Tube

Radios' Greatest Last-Minute Achievement.

Makes possible such circuits as

BEST'S SUPERHETERODYNE

DESCRIBED IN THIS ISSUE

Exclusively Specified!

The Shieldplate Tube, Type SP 122 is exclusively specified in Best's Superheterodyne—Tyrman "70" Shielded Grid Amplimax—Camfield Seven, and all other leading Shielded Grid Circuits.



NOTE THESE

6 POINTS of SUPERIORITY

1. Amplification constant is 175 compared with constant of 8 in general purpose tubes.
2. Oscillation is entirely eliminated.
3. It is self-neutralized.
4. "A" Battery drain is only .131 amperes.
5. Operates on 3 volts.
6. Brings in DX stations like locals.



Type SP 122

Price \$6.50

GUARANTEED

The Shieldplate Tube Corporation guarantees these tubes to be just as represented, or your money cheerfully refunded.

If your Jobber cannot supply you order direct from the factory. Include money order with your request or we will ship C. O. D.

JOBBERS and DEALERS

To insure immediate delivery wire your order today. All orders filled in rotation.

SHIELDPLATE TUBE CORP.

208 S. La Salle St.
Chicago, Ill.

- Shieldplate Tube Corp.
- Dept. R, 208 S. La Salle St.
- Chicago, Illinois
- Kindly send free booklet describing the Shielded Grid Tube, Type SP 122 and its many uses.
- Enclosed find check for \$..... Send me.....Shieldplate Tubes, Type SP 122.
- Name.....
- Address..... State.....
- Jobber.....

Veni Vidi Vici

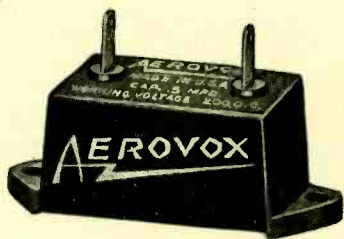

The 250

is the highest achievement in fixed bypass condenser design.

This model is a non inductive, 100% pure linen paper dielectric condenser, sealed in a Bakelite case and available in all capacities up to 1 mfd, rated at 200 volts D C working voltage. It can be used for every sort of bypass work where the working voltage is not in excess of 200 volts D C.



The 1475

The selection of this grid condenser for use in the "Best" superheterodyne is based upon electrical supremacy.

Here is a mica grid condenser molded in Bakelite, equipped with grid leak clips, and possessed of superior electrical characteristics. Accurate in capacity rating, permanent in capacity and impervious to moisture.



The 1450

is the mica condenser molded in Bakelite available in all capacity values up to .02 mfd, and suitable for use wherever a good fixed condenser is required. Hence its use in the "Best" Super.

Its electrical characteristics make it excellently suited as a fixed condenser in radio frequency circuits. Possessed of high insulation resistance, low radio frequency resistance, low power factor and being impervious to moisture, its use will materially aid the operation of any radio receiver.

THREE simple Latin words describe AEROVOX . . . I came . . . I saw . . . I conquered.

THE AEROVOX WIRELESS CORP. has compelled attention since its advent into the radio industry.

AEROVOX was new blood to the radio industry . . . and new blood means new life . . . new ideas . . . ceaseless, tireless effort.

AEROVOX represents the new school . . . research . . . vision . . . foresight, the power to look ahead . . . electrical design ahead of the times.

AGGRESSIVE perhaps . . . but possessed of modern knowledge underlying radio communication . . . knowledge which permits achievements . . . knowledge which culminated in wresting the leadership from older organizations.

THIS competent engineering-manufacturing organization has proved itself . . . its leadership. AEROVOX products are accepted as standards . . . are used by the best manufacturers . . . are selected by the best kit designers.

The condensers shown in the panel to the left have been selected by Mr. Gerald M. Best for his new superheterodyne, the first part of which is described in this issue.

AEROVOX

"Built Better"

70 Washington St., Brooklyn, N. Y.

PANELS for BEST'S New SUPER

DRILLED AND ENGRAVED BAKELITE PANELS AND SUB-PANELS—EXACTLY AS SPECIFIED BY GERALD M. BEST IN THIS ISSUE OF "RADIO"

Immediate Deliveries. Mail Orders Promptly Filled.

SAVE hours of time and labor. Let us supply you with the completely drilled, engraved and finished panels, sub-panels and bases for Gerald M. Best's new superheterodyne. Our business is to supply this material exactly as specified by Best. We have taken his original working drawings and have made our front panels, baseboards and sub-panels to his exact specifications. Each hole is drilled exactly where it ought to be. Our workmanship is guaranteed to be 100% accurate. Beautiful front panels in Bakelite, finished in walnut or black at your option. Holes drilled for drum dials, meter and controls. Engraving in white or gold for all control and dial markings, just as Best specifies. We are ready to make deliveries right now—TODAY. Eastern business solicited. We can supply any quantity of these panels on quick notice.

BAKELITE Panels

In walnut, curly walnut or mahogany. Exact size as specified by Best. All holes drilled. Fully engraved. White or gold..... **\$9.60**
In Black Bakelite..... **\$8.70**

BAKELITE Sub-Panels (Base-Board)

Best specifies a wood sub-panel but if you want to make a "De Luxe" receiver use a Bakelite Sub-Panel, cut, drilled and finished to exact specifications as shown by Best. Price of Bakelite Sub-Panel in black..... **\$8.90**

WOOD Base-Boards

A sturdy high grade wood baseboard, lacquer finished, with all cutting as shown in Best's picture diagram in this issue. Price..... **\$3.90**

We Carry a Complete Stock of Bakelite Rods, Sheets and Tubes. We Can Supply Panels for Any Kind of Sets

Panels for Any Kits described in "RADIO" or other magazines can be supplied to order. C. O. D. shipments made when half cash accompanies order.

*Dealers & Jobbers
please write
for details*

MAIL ORDERS

Complete sets of panels and sub-panels sent by parcel post on same day your order is received. Include postage for four pounds when parcel post shipments are wanted.

W. A. VETTER
24 Twelfth Street, San Francisco





"BRAIDITE"

Hook-Up Wire

"The Braid Slides Back"

Simply push back the insulation on Braidite, make your connection, solder it, and the insulation slides right back into place, leaving no exposed sections of bare wire. Braidite holds its shape permanently after bending and you cannot scorch or burn it with a soldering iron. Braidite is the easiest and fastest working hook-up wire made, yet it costs less than ordinary hook-up wires. Made in red, green, yellow, brown and black.

Braidite is specified in the "Best Super-Heterodyne" and other popular circuits.

25 ft. solid copper core 30c; 25 ft. stranded copper core, 35c.

"Corwico" Radio Wires are sold by all leading dealers. Order direct if your dealer can not supply you.

"Corwico" Radio Wires

"Best from the Ground Up"

- Antenna Wire (Solid, Stranded and Braided)
- Complete Aerial Kits
- Magnet Wire
- Battery Cable
- Bus Bar Wire
- Hook-up Wire
- Lead-in Wire
- Annunciator Wire
- Loop Aerial Wire
- Litz Wire
- Flexible Wire

CORNISH WIRE COMPANY
30 CHURCH ST., NEW YORK CITY

Complete Parts For:

G. M. BEST'S
SHIELDED GRID TUBE
SUPERHETERODYNE
\$140.00

HAMMARLUND-ROBERTS KIT
HI-Q SIX

All Ready to Change Over to
Shielded Grid Tube Operation.
\$75.00 Complete

All Parts in Stock for
"LYNCH NATIONAL FIVE"

Equamatic, Nine-In-Line, Infradyne, Brown-ing-Drake, Phasatrol, R. B. Lab., Cockaday 28, Tyrman Ten, Magnaformer, and other Popular Circuits.

Write Us First.

M. & H. Sporting Goods Co.

512A Market St.
Philadelphia, Pa.

How's Your Old Audio Amplifier

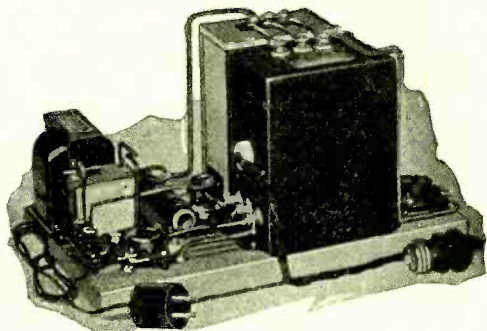
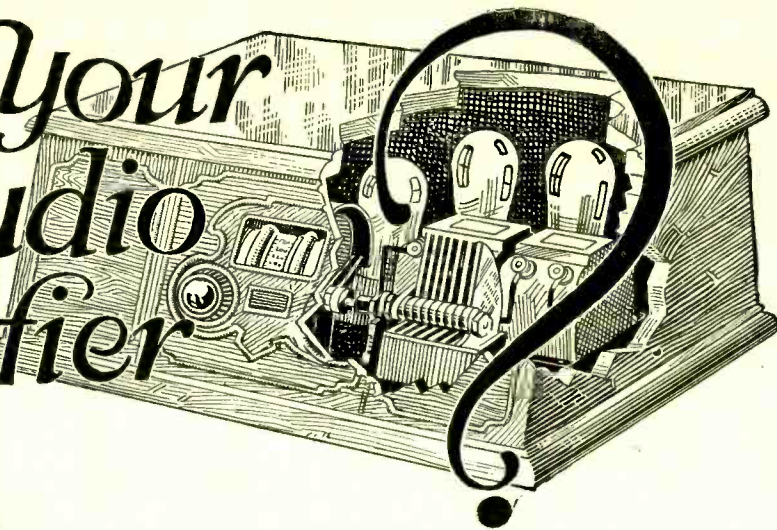

**THORDARSON 171 TYPE
POWER AMPLIFIER**

Built around the Thordarson Power Compact R-171, this power amplifier supplies "A," "B," and "C" current for one UX-171 power tube and B-voltage for the receiver. Employs Raytheon B. H. rectifier.

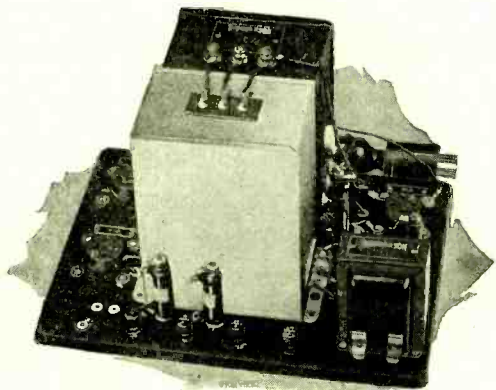

**THORDARSON 210 TYPE
POWER AMPLIFIER**

This amplifier, mounted on a special metal chassis, uses the Thordarson Power Compact R-210. Provides "A," "B," and "C" current for one UX-210 power tube and "B" voltage for the receiver. Employs one 216-B or 281 rectifier.

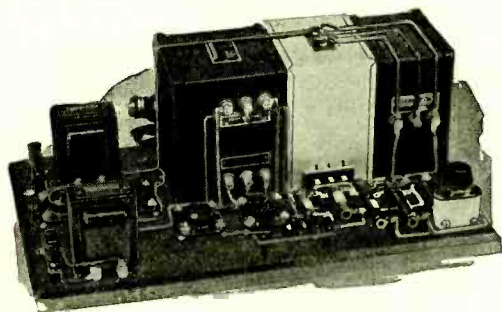

**THORDARSON 210 PUSH-PULL
POWER AMPLIFIER**

This heavy duty power amplifier operates two 210 power tubes in push-pull and has an ample reserve of power for "B" supply for the heaviest drain receivers. Built with Thordarson Power Transformer T-2098, and Double Choke Unit T-2099

A Home Assembled Thordarson Power Amplifier Will Make Your Receiver A Real Musical Instrument

IMPROVEMENTS in the newer model receiving sets are all centered around the audio amplifier. There is no reason, however, why you cannot bring your present receiver up to 1928 standards of tone quality by building your own Thordarson Power Amplifier.

With a screw driver, a pair of pliers and a soldering iron you can build any Thordarson Power Amplifier in an evening's time in your own home. Complete, simple pictorial diagrams are furnished with every power transformer.

{ The fact that Thordarson power transformers are used by such leading manufacturers as Victor, Brunswick, Federal, Philco and Willard insures you of unquestionable quality and performance. }

Give your radio set a chance to reproduce real music. Build a Thordarson Power Amplifier.

Write today for complete constructional booklets sent free on request.

THORDARSON

THORDARSON ELECTRIC MANUFACTURING CO.
Transformer Specialists Since 1895
WORLD'S OLDEST AND LARGEST EXCLUSIVE TRANSFORMER MAKERS
Huron and Kingsbury Streets — Chicago, Ill. U.S.A.

YAXLEY

APPROVED RADIO PRODUCTS

Cable
Connector Plug
Specified in the
BEST SUPER

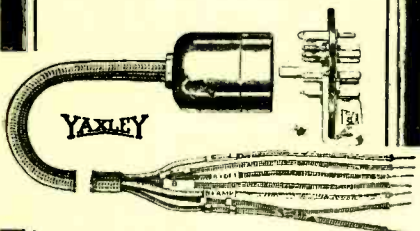

Every kit builder will get a great deal of satisfaction out of this radio convenience that brings battery wires to the set in one neat compact cable. The Cable Connector Plug shown above is for installing right in the set. Once hooked up, correct connections are assured—you cannot put it together improperly. For the BEST SUPER as well as for all leading sets insist on the Yaxley Cable Connector Plug.

At All Dealers

YAXLEY MFG. CO.
Dept. A—9 So. Clinton Street
Chicago, Ill.

A Fine New Log Book Just Out! 25 cents

We believe this to be the best and most practical log book yet issued. It is so complete and so simple to use that we can sell it to you on a money-back basis if you are not entirely convinced that it is the best booklet of its kind yet published. All the new listings, changes, etc., corrected to December 1st. Right up to date. Spaces provided for logging all stations in the U. S. and Canada. Send a quarter for your copy now. We pay the postage. Immediate deliveries.

“RADIO”

435 Pacific Building
San Francisco California

Better...by far...
than any speaker
at any price!

Jensen Dynamic Cone

We have listened to the \$1000.00 talking machines with their fine loud speakers—we have listened to practically every radio loud speaker made, but we have yet to find a speaker that approaches the qualities of the glorious new Jensen Dynamic Cone. Hear it once and you will never be satisfied with your present speaker. Introduced on the Pacific Coast several months ago by Peter Jensen, pioneer in dynamic speaker design. The entire output of the Jensen factory is being absorbed on the Coast but we are now in a position to make Eastern deliveries. We guarantee this new Dynamic speaker to outperform anything you have ever heard. It will be to your advantage to telegraph your order at once. The demand for this speaker is increasing so rapidly that it will soon be impossible to make prompt deliveries. Enjoy REAL music—faithful reproduction with enormous volume of all frequencies from 20 to 8000 cycles. Built-in step down transformer. Will stand full undistorted output of 210 amplifier tubes.

Prices . . .

Speaker without cabinet but with complete mechanism and connecting cords. Can be built into any phonograph or radio cabinet.

\$47.50

Complete speaker built into a beautifully finished mahogany cabinet, grilled front and rear.

\$65.00

A. C. OPERATION

The field of the Jensen speaker is energized from either a 6 volt storage battery or it can be made to operate from your light socket by using any small ½ ampere trickle charger such as Kuprox, Retrox or others. This makes it a completely AC operated speaker. No battery required.

CUSTOM - BUILT POWER SPEAKER

Let us build a Thordarson 210 transformer and a 1000 volt guaranteed condenser into the Jensen cabinet to convert it into a 210 power speaker. Price, built to your order, including transformer, condenser block, sockets, resistances and CX310 power tube and CX381 rectifier tube, with cable connections for all wiring to set—complete for \$130.00 ready to operate. All wiring in place. Tube Filaments lighted by A. C. Unquestionably the greatest loud speaker you have heard. Deliveries subject to 5 days delay. Dealers please write.

Radio Constructors Corp.
357 12th Street, Oakland, California

Laboratory TESTED PARTS from “RADIO” Laboratory



The experienced radio man knows what “LABORATORY MATCHED AND TESTED” means when it comes to getting results from a home-built radio set. D. B. McGown, Laboratorian for “RADIO,” has at his disposal a completely equipped testing and calibration laboratory. We can supply you with matched parts for building any of the new 1928 kits or power supply devices. We make no charge for testing and matching the parts. We charge you the regular retail prices as advertised by the manufacturers for the parts you purchase from us. We specialize in matching intermediate transformers; calibrating wavemeters; matching coils and condensers; “chasing bugs” in multi-tube sets and giving you expert advice on your radio problems.

Write to D. B. McGown—tell him what you want to build and he will get the parts for you. Immediate shipments cannot be made. It takes several days to test and match the parts. In some cases it may be necessary to delay shipment for a week or more. But you get the assurance of success in advance if you use this service. Sets re-wired for A. C. Operation. Prices on request.

Write for Estimate on Special Jobs

D. B. MCGOWN
LABORATORIAN

435 PACIFIC BUILDING
SAN FRANCISCO CALIFORNIA

Full Size Working Drawings and Instructions for building the new Gerald M. Best SUPER HETERODYNE

OFFICIAL constructional details by Gerald M. Best himself will assist you in building his new receiver described in this issue of "RADIO." The data comes to you in one package and includes a full size working print for drilling the panel; another for the base-board layout; another for wiring the entire receiver (in pictorial form) and smaller sketches of the schematic circuit as well as pictures show-

ing the assembly of the various parts. Much thought has been given to these plans and they will assure you of success in advance if you contemplate building this great receiver. An instruction pamphlet containing Best's story on the new Super goes with the prints. The instructions are guaranteed to be accurate. They simplify the building of the receiver. Deliveries will be made starting January 1st and orders should be sent now.

\$1.00
is the cost for the complete set of full size prints and instructions. Sent postpaid anywhere.

The Coupon Makes it Easy to Order. Attach a one dollar bill, check or money order to it and mail now. Your prints will be sent to you not later than January first.

DEALERS AND JOBBERS
are urged to write at once for territory

"RADIO," 435 Pacific Building,
San Francisco, California

I am sending a dollar with this coupon for which you will mail me, no later than January 1st, a complete set of instructions and full size working prints for building Gerald M. Best's 1928 Superheterodyne as described in "RADIO" for January.

Name.....
Address.....
City and State.....

Selected for
its Quality

FROST-RADIO

Again is exclusively
Specified by Gerald M. Best,
who now selects it for his new
Revolutionary 1928 Superheterodyne



FROST-RADIO



FROST-RADIO

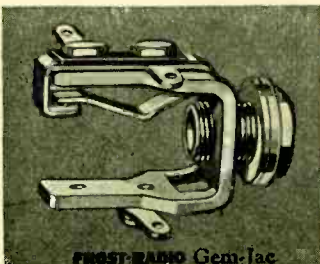

FROST-RADIO Gem-Jac

IN specifying Frost-Radio for exclusive use in his startling and revolutionary 1928 Superheterodyne, Gerald M. Best again shows the implicit confidence he places in these famous parts. Mr. Best has specified Frost-Radio on numerous occasions in his other circuits because he has found it admirably suited to the quality of reception his circuits must and do deliver.

In his 1928 Super Mr. Best makes use of the following Frost-Radio parts:

- 1 S-1910 10 ohm Frost Gem Rheostat, with combined filament switch.
- 1 No. 1922 200 ohm Gem Potentiometer.
- 1 No. 1882 200,000 ohm Frost De Luxe Variable High Resistance Unit.
- 1 No. 954 Frost Single Closed Circuit Gem-Jac.

When you build Best's 1928 Super be sure to use only genuine Frost parts, as specified. Your dealer can supply these parts. See him today.

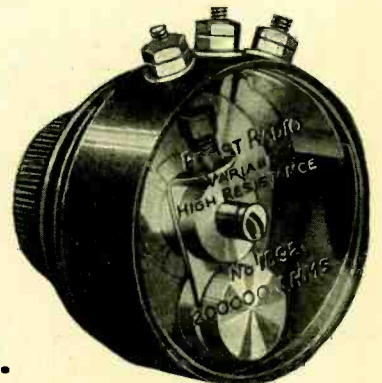

FROST-RADIO

HERBERT H. FROST, INC.

NEW YORK

ELKHART, IND.

CHICAGO

*Our Cabinets are
Specified by
Gerald M. Best
for his Superheterodyne*

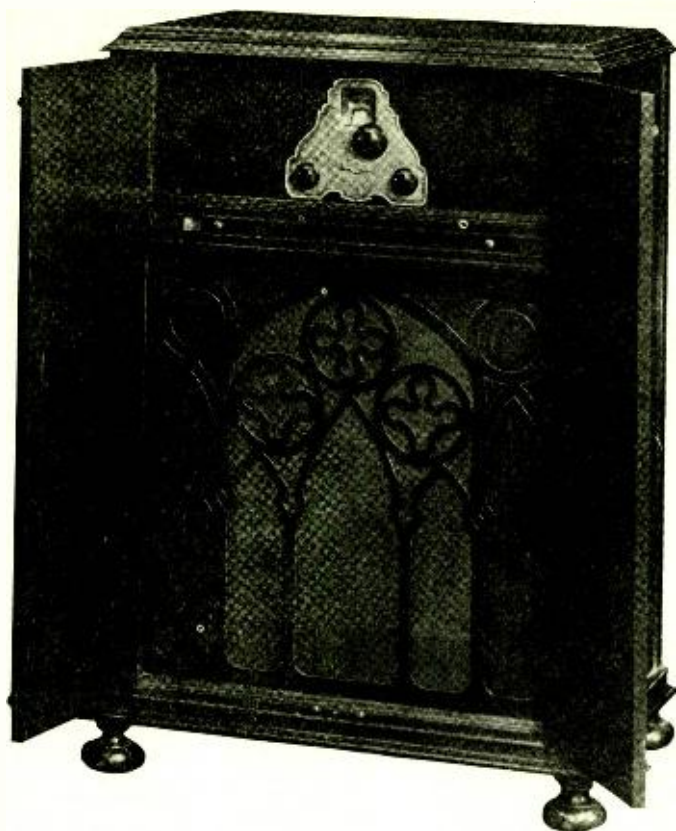

*Also in Table Model
for Best's Super
7" x 26" x 11"*

The Newest — the Classic Console

The exquisite beauty of the Chillicothe Radio Console, is creating a sensation among radio owners. Every set owner desires the enhancing artistry, so accurately expressed in this most attractive and convenient cabinet. "The Classic" Console is faultlessly constructed of genuine black walnut, "that master of woods."

A long air column Newcombe-Hawley horn with Baldwin unit,—standard equipment.

Sufficient space in lower compartment for all types of battery and electrical equipment.

A walnut panel which will accommodate all sets up to 26½" x 9".

A specially built table model cabinet, 7" x 26" x 11" for

Gerald M. Best's Superheterodyne, exactly as specified in this issue of "RADIO" is now ready for the market.

The above are additional advantages of this Chillicothe Console.

Here—in this new creation by the Chillicothe Furniture Company, you will find authentic distinctive design, simplicity and unsurpassed convenience,—truly a pleasant combination.

Interesting booklets on Chillicothe radio cabinets will be cheerfully mailed upon request. A letter to Department R, Chillicothe Furniture Company, Inc., Chillicothe, Missouri, will demonstrate how these cabinets will improve your set.

CONSTRUCTION

The same ideals which the Chillicothe Furniture Company has at all times expressed in the construction of their genuine Walnut Dining Room Suites, have been carried into this new field of radio cabinets, and built in "the Walnut center of America," by this reliable firm, you are assured of a radio cabinet superb.

"Built in the Walnut Center of America"

**CHILLICOTHE
RADIO CABINETS
CHILLICOTHE FURNITURE COMPANY
INCORPORATED
CHILLICOTHE, MISSOURI**

Tell them that you saw it in RADIO

Electrify your radio set with

Majestic

"A" and "B" Electric Power Units



No Acids — No Liquids
No Hum — DRY

Gives any radio set full strength, permanent Electrical "A" and "B" power all the time. Both "A" and "B" power and your radio set, all controlled by one switch. Only one light socket connection necessary.

See your dealer — NOW!

GRIGSBY-GRUNOW-HINDS COMPANY
4540 ARMITAGE AVE. CHICAGO, ILL.

W. J. SEROY
Pacific Coast Sales Manager
122 BROADWAY, OAKLAND, CALIF.

Tell them that you saw it in RADIO

AMER TRAN - AMER TRAN - AMER TRAN - AMER TRAN

Fidelity of REPRODUCTION

*AMERTRAN Presents
a new completely
assembled audio
unit*



*The
AMER TRAN
Push-Pull Power
Amplifier*

*Sets a new standard
of quality in audio
amplification*

The AmerTran Push-Pull Power Amplifier is a new completely assembled two-stage unit. It contains a first stage AmerTran DeLuxe followed by AmerTran Input and Output Transformers for Power Tubes. When operated from a power source supplying sufficient voltage, (such as the new AmerTran A-B-C Hi-Power Box) the input to the speaker is almost perfect, and fidelity of reproduction is limited only by the ability of the speaker. Distortion, from tube harmonics and AC hum, is reduced to a minimum. The energy output to the speaker is increased, especially at the lower musical frequencies. This means greater clarity of tone at low or high volume.

The amplifier is easily connected to the detector of any good receiver, replacing its audio amplifier. It is equipped with four sockets, two for power tubes, and a four-prong and a five-prong socket in the first stage for either a standard amplifying tube of the UX-201-A type, or a UY-227 AC tube. Using the latter tube, the amplifier can be entirely AC operated.

AmerTran Push-Pull Amplifier as a complete unit is licensed under patents owned or controlled by the Radio Corporation of America and must be sold complete with tubes. It is built in several types, depending on the type of power tubes preferred. Type 2 AP-10 is designed for 210 tubes and type 2 AP-71 for 171 tubes. The difference is only in the Push-Pull output transformers.

This completely wired licensed AmerTran Push-Pull Amplifier is on display and demonstration at stores displaying the sign "Authorized AmerTran Dealer." Send for complete literature on this new AmerTran Unit.

AMERICAN TRANSFORMER CO.

178 EMMET STREET

NEWARK, N. J.

"Transformer Builders for Over 26 Years"

Pacific Coast Office: CHRONICLE BLDG., SAN FRANCISCO

*Connects to the
detector of any
good set*

AMER TRAN - AMER TRAN - AMER TRAN -

Get True Musical Reception

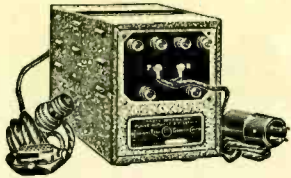

Combination

List \$70.00 [Without Tubes]

Special at \$23⁵⁰_{EA.}

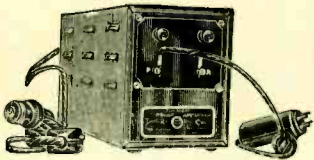

Power Amplifier



List \$45.00 [Without Tubes]

TIMMONS Power Amplifier

Special at \$15⁵⁰_{EA.}

Both of these high quality compact units use a U.X. 216B or 281 tube for rectifying and a U.X. 210 super power audio tube as an amplifier which gives distortionless and true natural reception with wonderful tone quality and volume.

Both instruments are identical in their performance as super power amplifiers. The combination however is also a complete "B" Eliminator furnishing all the "B" current

required by the regular tubes of the set. No adjustments required and no output transformer or similar auxiliary equipment needed with either unit.

For use with alternating current 105 - 120 volts, 50 - 60 cycles.

Every unit is brand new, packed in original factory sealed carton and fully guaranteed. They have been approved by Popular Radio and Popular Science Laboratories.

AMERICAN SALES CO., 21 WARREN ST., NEW YORK CITY

TREGOSIX CONSOLE

A Great Two Dial Six Tube Receiver

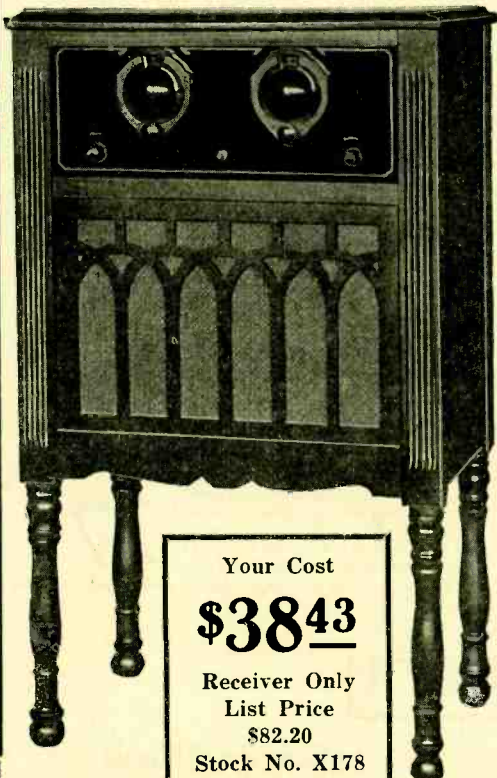

Now get the master stroke of six tube radio. The Tregosix console—perfect in wave selectivity, but with the precision of a watch—so simply constructed a child can operate it. It has power to reproduce rich tone volume. Compare it with sets selling for twice its price and you will find it more carefully constructed. When you hear the pleasing reproduction of the tone as it is portrayed by the genuine Baldwin speaker units you will be genuinely surprised. Plenty of room is provided for "A," "B" and "C" batteries and the customers getting them are always pleased. The price is so low that dealers are making big profits on these. They are able to meet any competition and still have a nice profit left.

Your Cost
\$52.82
Stock No.
X179

**Complete Combination
Battery Equipped**

1 Tregosix Console	\$ 82.20
3 2303 45 volt Ray-O-Vac "B" battery.....	11.25
1 4½-volt Ray-O-Vac "C" battery.....	.60
1 100-amp. "A" battery	19.00
6 X201A Trego tubes.....	10.50
1 Trego aerial equipment.....	2.50
List Price.....	\$126.05

Your Cost
\$38⁴³

Receiver Only
List Price
\$82.20
Stock No. X178

TREGO RADIO MFG. CO.

1427 CHESTNUT ST.

KANSAS CITY, MISSOURI

DEALERS WRITE FOR FREE CATALOG.

Abox

"A" BATTERY ELIMINATOR

Licensed by The
Andrews-Hammond Corporation,
under Patent No. 1,637,
795 and applications

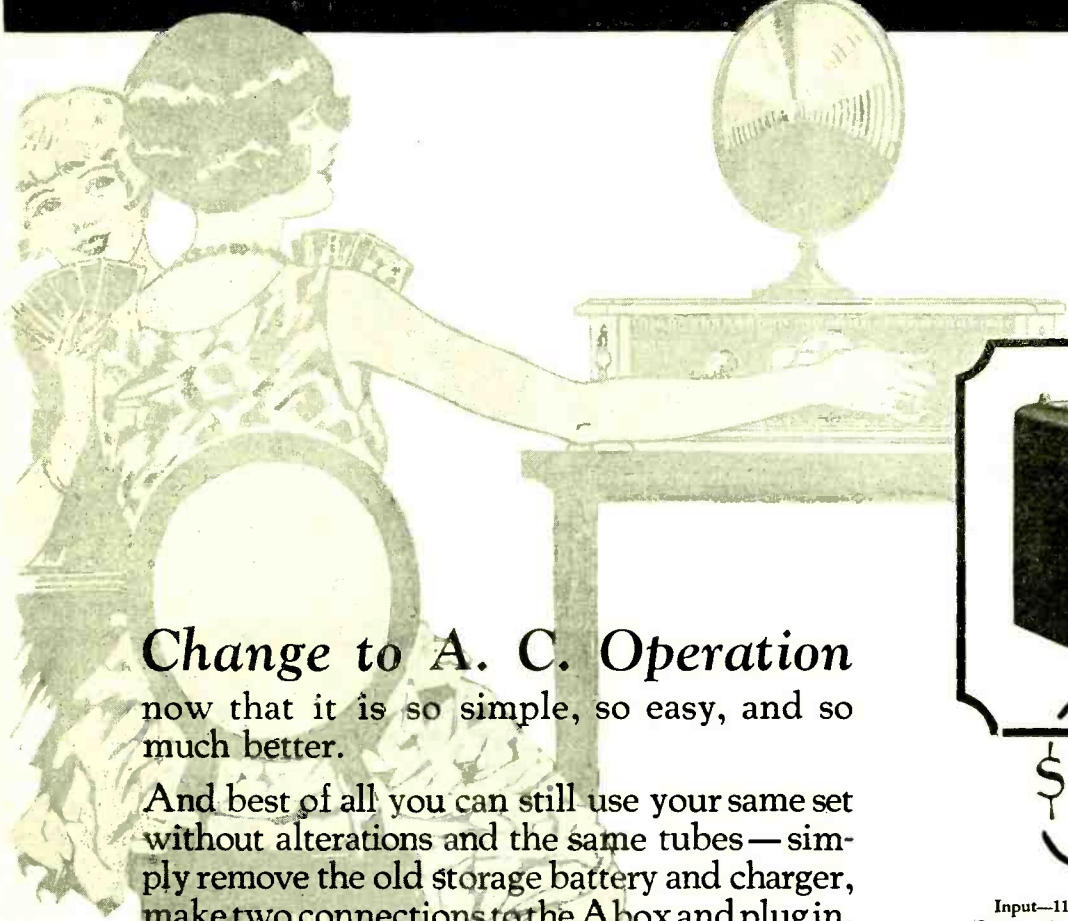

Change to A. C. Operation

now that it is so simple, so easy, and so much better.

And best of all you can still use your same set without alterations and the same tubes—simply remove the old storage battery and charger, make two connections to the Abox and plug in.

The Abox draws current from the light socket only when the set is in use. *It contains no battery.*

The ABOX "A" ELIMINATOR is made in two models, one for sets using eight or less 6-volt tubes, including the new A type power tubes, and one for sets using ten or less 4-volt tubes.

Any "B" Eliminator can be used in connection with an ABOX to completely electrify your radio set. For full information see your dealer or write direct for free descriptive circulars.

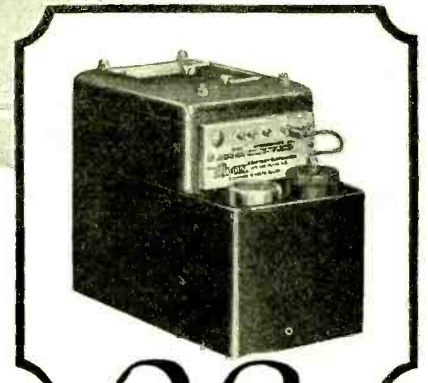

\$ 32⁵⁰

Input—110 volts, 50-60 cycles A. C.
Output—6-volt direct current, 2 amperes.
Shipping weight, 25 lbs.

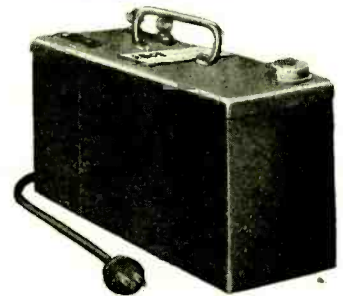

Four-volt model for sets using 4-volt tubes. Fits Radiola battery compartment. Size, 8³/₄ inches long, 4 inches wide, 6¹/₂ inches high. Output—6 amperes, 4 volts D. C. Price

\$ 27⁵⁰

All prices slightly higher on West Coast

The Abox Company

215 North Michigan Avenue

Chicago, Illinois

RADIO

WITH WHICH IS INCORPORATED "RADIO JOURNAL"

VOLUME X

JANUARY, 1928

No. 1

Radiatorial Comment

The general advance in radio during 1927 has surpassed that of any preceding year, largely because it represented the culmination of efforts extending over several years. Perhaps the most noteworthy event of the year was the beginning of legal control of broadcasting. After six years of urging, Congress finally passed the radio act which established the Federal Radio Commission.

What of 1927?

This Commission has made a good start in the stupendous task of rectifying the chaos into which broadcasting had fallen. It has been unfortunate in the loss of three of its members by death or resignation. But with its announcement that the number of stations is to be reduced from seven to four hundred early in February there is good probability of its being able to bring about relatively uninterrupted reception.

Another noteworthy event was the International Telegraph Conference at Washington. Its recommendations as to the allocation of wavelengths and for the regulation of the various communication services now need only the formal approval of the eighty governments concerned in order to become international law. Relatively few changes were made in the assignments above 200 meters. The channels from 10 to 100 kilocycles were reserved chiefly for long distance transoceanic service, from 100 to 500 kilocycles for ship to shore and aircraft service, and from 500 to 1500 kilocycles for broadcasting.

The great band below 200 meters was apportioned into forty or more channels to be used for four or five kinds of service. Among these, the amateurs were given well-deserved recognition for their pioneer work in this field. In view of the value of their work, future as well as past, it appears that they have not been given sufficient diversity in channels to allow their most effective utilization. They were given but three exclusive channels, a 300 k.c. band between 42.8 and 41 meters, a 400 k.c. channel between 21.4 and 20.8 meters, and those wavelengths below 13.1 meters. They share with other services the bands from 175 to 150 meters, and from 85 to 75 meters. Five short-wave channels are assigned to broadcasting and the others are reserved for fixed or mobile stations.

The regulations were strengthened to provide for greater safety of life and property at sea and to give priority to distress communications. No more spark sets are to be installed one year after adoption and all existing spark sets shall be replaced with C.W. within a definite period of years. In those countries where radio communication is maintained by private companies the latter are free to establish rules on those questions which are naturally within their own province.

The greatest technical advances of the year were in the studies of methods of radio propagation and of causes of fading. So much has been learned in this field that it is now possible to prophesy the results that may be expected when using different short wavelengths at different times of the day and night.

Technical Advance

Great strides have been made in the application of radio to aviation. Safety in flying has been enhanced not only by beacons for guidance but by direct communication to and from planes in flight. Radio seems destined to be of even greater service to ships of the air than it has been to ships of the sea.

This year has witnessed the establishment of regular transoceanic telephony and of picture transmission. The latter bids fair to replace code transmission of written messages for many commercial purposes. Success has also been attained in the experimental transmission of moving pictures and television, though not yet to the degree required for commercial application.

The year's greatest single advance in radio reception was the shielded grid tube. By its use extreme long distance reception can become a frequent occurrence. Not only does it give tremendously greater amplification and quieter operation than other tubes, but also it removes the necessity for neutralizing tuned radio frequency circuits. But the most wide-sweeping innovation in receiver design was the general introduction of tubes which use alternating current for filament supply. This, in connection with single control drum dials, has brought operation to such simplicity that the veriest tyro can use a set.

In transmission, aside from the expansion in the field of the shorter waves, the most significant feature was the general adoption of quartz crystals for controlling transmission frequencies. In these days of congested broadcast channels this has become almost a necessity to prevent interference. The success of British stations in the use of short-wave beam transmission is also worthy of mention in this brief review.

From the financial standpoint the industry became much more stable, partly through the potent influence of the R. C. A. policy of licensing other manufacturers under its patents. The general tendency seems to be toward fewer and stronger manufacturers.

Financially

The preceding instances are merely the highlights in the general picture of progress. In the background, thousands of inventors and experimenters are patiently working to improve existing equipment. A broad survey indicates that radio has finally passed through its revolutionary stages and is getting into its stride of steady onward evolution.

The 115 Kilocycle Superheterodyne

With Shielded Grid Tubes in Two Stages of R. F. and I. F. Amplification
So As to Give Unequalled Sensitivity, Selectivity and Quietness

By Gerald M. Best

THE shielded grid tube has made possible some radical departures in the conventional design of a superheterodyne, notably in the intermediate frequency amplifier. It has been found that this tube is especially adapted to amplification at frequencies from 50 to 150 kilocycles, and that by the use of a tuned circuit it is possible to build up a very high load impedance, thereby permitting voltage amplification as high as 200 per stage. By designing these tuned circuits for 115 kilocycles, not only is a remarkable degree of amplification and selectivity obtained with two stages, but also the two settings of the oscillator dial are separated to such an extent that interference between various stations on the oscillator dial is practically eliminated.

This new superheterodyne uses 9 tubes, of which four are of the shielded grid type, two being used in the preliminary tuned r.f. amplifier ahead of the mixer tube, and two in the intermediate amplifier. This combination gives a degree of selectivity and sensitivity beyond anything heretofore offered to the public: 10 kilocycle selectivity with a sufficiently broad peak to the curve of tuned circuits so that the audio frequency component of the carrier wave is not impaired by too sharp a cut-off; total amplification to an enormous figure, permitting as a practical example, unimpaired reception of WLW, 700 kilocycles, 2000 miles distant, through KPO, 710 kilocycles, one mile distant.

In addition to its unsurpassed sensitivity and selectivity, the most notice-



Panel View of Superheterodyne.

able feature of the set is its quietness of operation. When the aerial is disconnected the set is absolutely quiet. Other advantages are the ease of assembly and the simplicity of operation, with but two tuning controls of the drum dials and ganged condensers.

The two stages of tuned r.f. ahead of the mixer tube provide selectivity and add sensitivity. By the use of an antenna compensator, the receiver may be adjusted to suit any length of antenna, with adjustments for extremely loose, medium or close coupling, depending on local conditions. Contrary to the suggested impedance coupled circuit shown in the circular accompanying the shielded grid tube, the r. f. amplifier uses a type of transformer coupling which is superior to impedance coupling in both selectivity and sensitivity.

By the use of knock-down stage units, consisting of a copper case, plug-in coils, sockets, resistances and by-pass condensers, a uniform and easily wired receiver is made possible. The two r.f. amplifiers, mixer, oscillator, two intermediate amplifiers, and the detector, with their associated apparatus, are each housed in separate compartments. The shields are drilled for the sockets and coil mountings, and have holes in the

base through which are passed the inter-connecting wires.

The tuning controls are located on a front panel of conventional design, with two illuminated drum dials, one controlling a 3 gang condenser for the r.f. amplifier, and the other operating the oscillator tuning condenser. Adjustments of filament voltage, with voltmeter, are provided, and the antenna compensator, volume control and output jack complete the panel apparatus.

The sub-panel apparatus is all mounted on a baseboard 11x26x $\frac{3}{4}$ in., as such a method is the most economical, and since practically all apparatus is placed in shielded compartments, the material on which it is mounted is not an important factor. Bakelite or aluminum sub-panels may be used if the added expense is not prohibitive; the latter type may be obtained cut to size, with raised edges, from one of the large aluminum product manufacturers.

If a cabinet having grooves for sliding the set into place is used, the baseboard should be recessed at each end where it joins the front panel so as to clear the panel supports on the cabinet.

The tubes may be enclosed in a tube weight and shield, which stops microphonic noise from the tube and prevents coupling between the coils and the tube elements. A hole in the top of the tube shield permits connection to the control grid terminal on the top of the tube, in the case of the shielded grid variety.

As the shielded grid tube has a 3.3 volt filament, drawing .12 amperes, CX-299 tubes are used for the mixer, oscil-

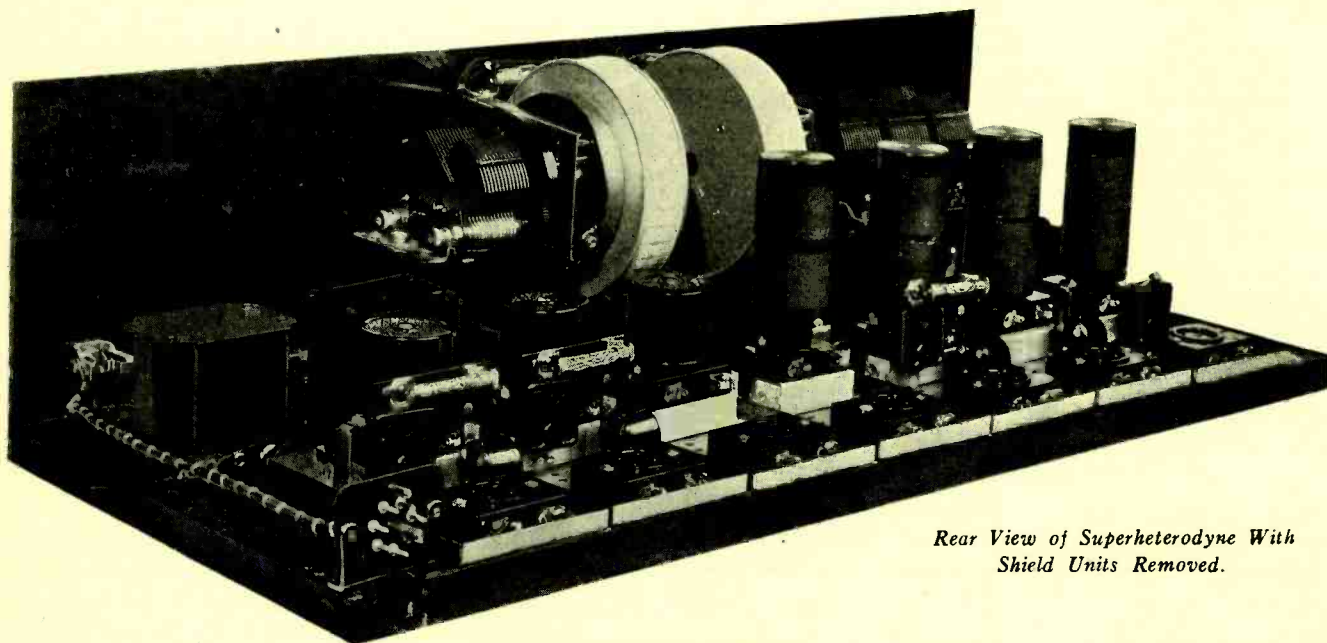

Rear View of Superheterodyne With
Shield Units Removed.

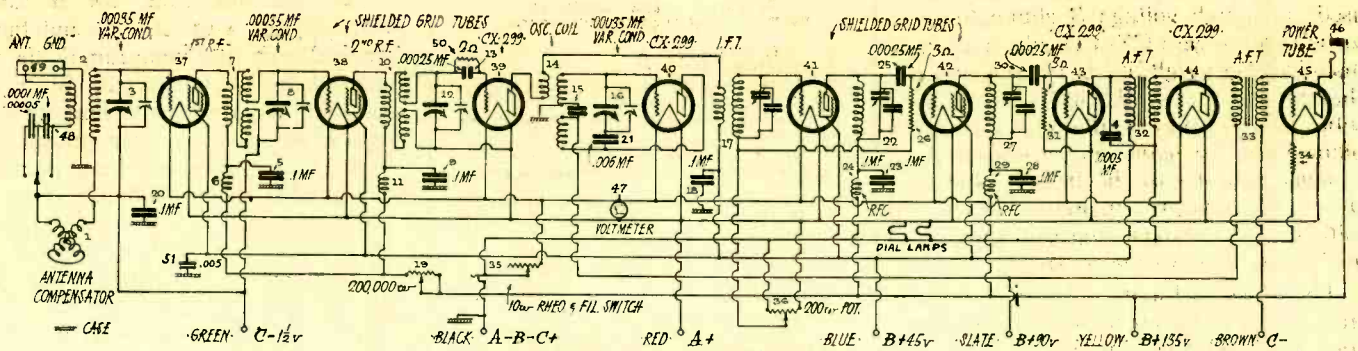

Fig. 1. Schematic Wiring Diagram.

lator, detector and first audio stages, so that there are no complicated filament circuits to confuse the builder. These tubes have been found adequate in amplification and power output, for the purpose they are used, and nothing will be gained by installing storage battery tubes in their place. The model which is being described in this issue uses a CX-112 power tube, which can either be operated from raw a.c. for the filament power, or from the same 6 volt storage battery or A eliminator used for the remaining tubes in the set. The latter is the case in the schematic wiring diagram, which is shown in Fig. 1. In a subsequent issue of RADIO, a combined power plant and amplifier using a type 310 power tube will be described, so that only one stage of audio will be required in the set itself. If the recently announced CX-112-A power tube is used, the 2 ohm fixed resistance No. 34 as shown in Fig. 1 should be changed to 4 ohms.

Referring to Fig. 1, the two stage tuned r.f. amplifier consists of an antenna coupler of the solenoid type with an antenna compensator placed in series with the secondary; two r.f. transformers of special design, and arranged for use with the shielded grid tubes; and a set of r.f. chokes and by-pass condensers. The latter are placed in the B supply leads, with the condensers connected to ground.

The mixer tube is of the grid condenser-leak type, with the energy from the oscillator admitted through a pick-up coil in the plate circuit. The oscillator is similar in design to that used in past models of the superheterodyne, except that fixed coupling is employed, the variable method not being necessary or

advisable in this case. The output of the mixer is coupled to the intermediate amplifier by means of a tuned transformer, sharply peaked at 115 kilocycles, but with an adjusting screw and associated vernier condenser provided so that the intermediate frequency can be adjusted over a range of about 5 kilocycles so as to compensate for differences in tubes.

a minimum amount of space. The detector tube is housed in a compartment along with the tuned impedance and r.f. chokes associated with the second intermediate amplifier, and the output of the detector is fed directly into the two stage audio amplifier, which is located between the group of stage units and the front panel,

The sensitivity of the intermediate

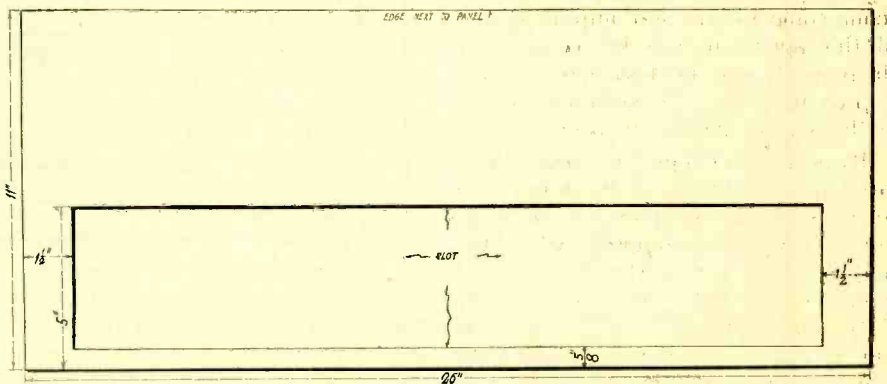

Fig. 2. Dimensions of Baseboard.

The two stage shielded grid tube intermediate amplifier employs tuned impedances, accurately adjusted to 115 kilocycles, so that the greatest possible amount of amplification can be obtained. Each tuned impedance is equipped with an adjusting screw, so that the entire intermediate amplifier can be lined up after the set is wired, without the necessity of a laboratory test. The r.f. transformer and the tuned impedances are of the plug-in variety, with special sockets equipped with supports so that the by-pass condensers can be placed underneath the sockets, thus occupying

an amplifier is adjusted by means of a 200 ohm potentiometer; it has been found that once this adjustment is made, the volume on any station can be controlled by the main volume control, which is a 200,000 ohm variable resistor in the B voltage supply line to the tuned r.f. amplifier. Hence, the intermediate amplifier adjustment can be made once for all, and left fixed, unless a change in tubes or B voltage is made.

A list of parts used in the new receiver is given so that the receiver may be duplicated with a minimum amount of trouble. For battery operation, the CX-

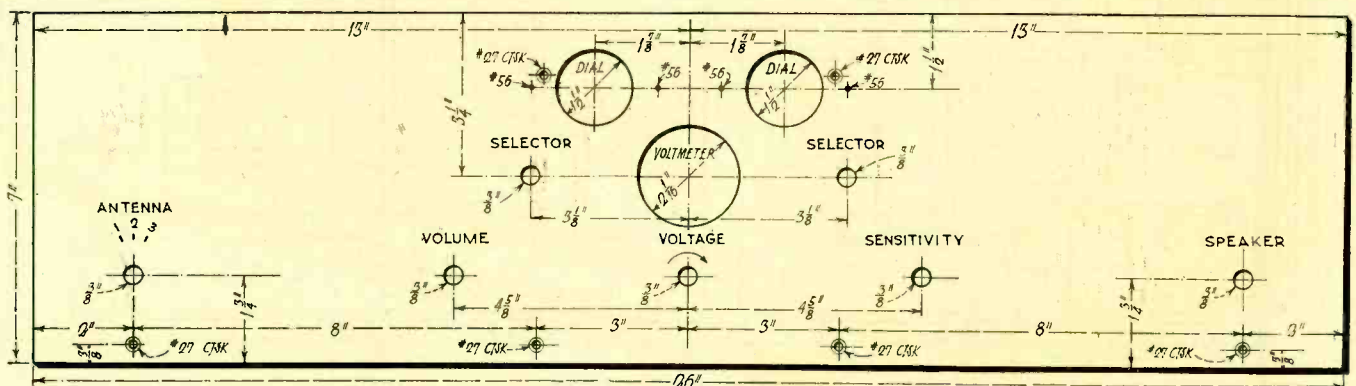

Fig. 3. Panel Drilling Dimensions.

112 or CX-371 power tubes may be used; if a high voltage *B* eliminator is to be used, a type CX-310 tube may be installed, although it is recommended that in the case of the latter, that the tube be incorporated into the *B* power plant itself, to avoid a.c. leads in the receiver, parallel to the battery wiring. In the parts list, the figures in brackets refer to the corresponding coil numbers on the pictorial wiring diagram, Fig. 4.

The baseboard is first cut to size, and then a slot is cut out in accordance with the directions given in Fig. 2, so that the wiring can be run underneath the shielded unit assembly, without projecting underneath the baseboard. It can then be fastened to the front panel, either by screws through the bottom edge of the panel, or by means of brackets, whichever is preferred. On the front panel are mounted the two drum dials, using the drilling template furnished with each dial for the exact dimensions, and Fig. 3 for the position of the holes for mounting the filament rheostat, voltmeter, volume controls, antenna compensator, and output jack. All of this apparatus can be mounted on the panel, before the baseboard assembly is prepared, and a considerable amount of the wiring done at the same time.

To prevent microphonic noises due to mechanical vibration of the tubes, all of them, with the exception of the power tube, may be equipped with tube weights and shields, which can be obtained in one unit. The shields for the shielded-grid tubes have a hole in the top so as to pass the control grid terminal. Unless the shielded-grid tubes have a weight on the top, they are quite likely to be microphonic, especially if they are giving a high degree of amplification, so that the combination weight and shield serves a double purpose.

The use of these shields is optional however, except for the mixer and detector tubes.

LIST OF PARTS USED IN BEST'S 115 SUPERHETERODYNE	
1—	Panel 7x26x3/16 in.
1—	Baseboard 11x26x3/4 in.
7—	Remler No. 720 shielding cases
2—	Remler No. 110 drum dials
4—	Shielded grid tubes—Shieldplate Tube Corp.
4—	CX-299 Cunningham tubes
1—	CX-112-A or 371-A Cunningham power tube
1—	Remler No. 633 variable condenser
1—	Remler No. 638 variable condenser
1—	Remler No. 550 interchangeable inductance —(2)
1—	Remler No. 570 interchangeable inductance —(14)
2—	Remler No. 560 interchangeable inductances —(7, 10)
1—	Remler No. 612 interchangeable inductance, 115 K.C. —(17)
2—	Remler No. 614 interchangeable inductances, 115 K.C. —(22, 27)
16—	Remler No. 50 sockets
1—	Frost No. 954 jack
3—	Remler No. 61 Resistance Mountings
1—	Yaxley No. 660 cable connector plug
1—	Weston Model 506 voltmeter, 0-5 volts
1—	Remler No. 502 antenna compensator
1—	Remler No. DK-10 knob
2—	Remler No. 750-12 knobs
2—	Amertran deluxe audio transformers, 1st and 2nd stage
1—	Frost No. S-1910 Gem rheostat, 10 ohms
1—	Frost No. 1882 deluxe high resistance, 200,000 ohms
1—	Frost No. 1922 Gem potentiometer—200 ohms
7—	Aerovox .1 mfd. bypass condensers
3—	Aerovox .00025 mfd. No. 1450 condensers
1—	Aerovox .0005 mfd. No. 1450 condenser
1—	Aerovox .006 mfd. No. 1450 condenser
1—	Aerovox .005 mfd. No. 1450 condenser
1—	Aerovox .0001 mfd. No. 1450 condenser
1—	Aerovox .00005 mfd. No. 1450 condenser
4—	Remler No. 35 choke coils
2—	Eby binding posts
1—	Frost 2 ohm fixed resistor
2—	Durham 3 megohm leaks
1—	Durham 2 megohm leak
2—	Rolls, 25 ft. each, Cornish "Braidite" wire
3—	Remler No. 54 ballast-shields (optional)
4—	Remler No. 55 ballast-shields (optional)

The windings of the interchangeable inductances are connected to the socket terminals as follows: That end of the primary which is to be connected to the positive "B" supply goes to the grid terminal of the socket. The plate terminal of the primary goes to the plate terminal of the socket, the filament end of the secondary is connected to the positive filament terminal of the socket, and the grid end of the secondary goes to the negative filament terminal of the socket.

The shielding cases are of formed sheet copper, with the top and bottom removable so that mounting of the parts and wiring is facilitated. With each case are supplied two brass brackets, with screws and nuts, to support the coil socket above the shield base, permitting the placing of the by-pass condensers underneath the socket. The brackets are made to accommodate Aerovox type 200 condensers, although other types may be used if preferred.

The 7 bottom sections of the units are placed 1/8 in. apart in a row over the slot cut in the baseboard, leaving a margin of approximately 5/8 in. at each end. Their position can readily be determined by referring to the picture at the rear of the receiver, with the apparatus in place on the bottom sections of the shields. The audio transformers and audio tube sockets should be fastened to the baseboard next, together with the cable plug terminal and the set of fixed condensers which are used in the antenna circuit.

The pictorial wiring diagram, Fig. 4, shows the exact position of each piece of apparatus in the various compartments. The tube and coil sockets are furnished with supports which are drilled for mounting screws, and these are fastened in place, two to each compartment, with the bypass condensers underneath the sockets, where required. The tubes go at the rear of the compartments, with the coils towards the front panel. The plate lead from each tube passes through a hole in the bottom of the compartment, underneath the baseboard, and up through another hole in the next compartment to the primary of the following transformer. *B* battery, grid return and *A* battery leads are all run through holes in the compartments, so that there will be no wiring visible on the top of the set except to such apparatus as is located on the panel, or in the audio amplifier circuit.

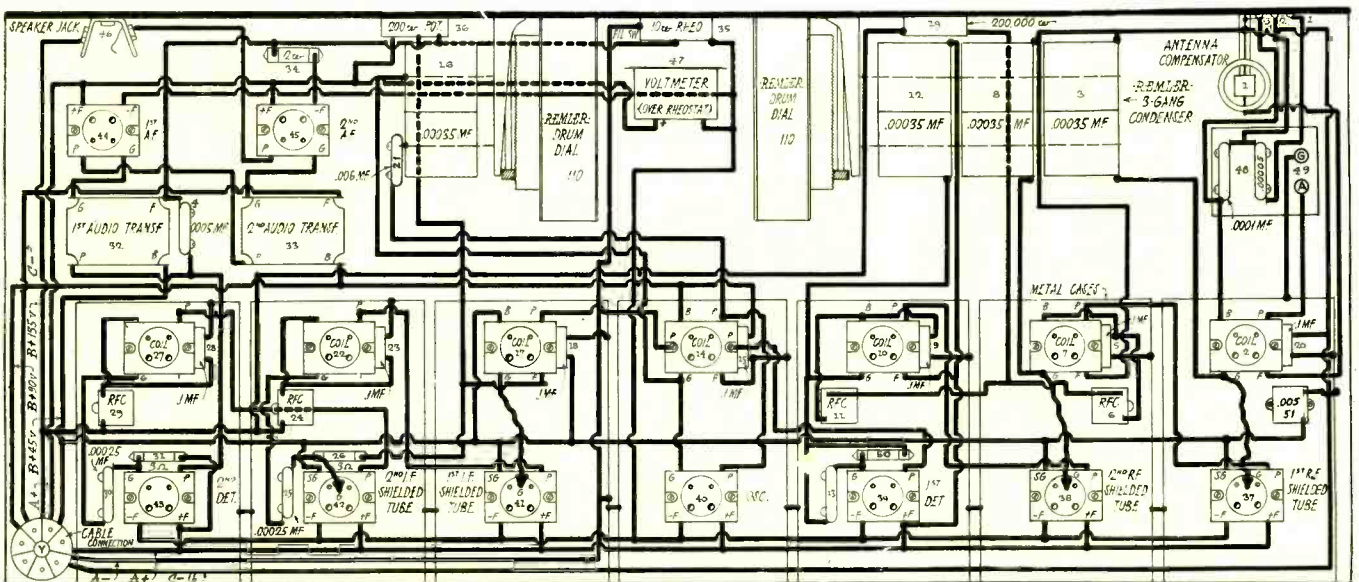

Fig. 4. Pictorial Wiring Diagram, Showing Layout of Apparatus.

After all wires connecting the seven compartments are in place, the cans may be slipped down on the flanges of the bottom plates, and the lids can then be placed on top of the cans, to complete the box shield. Each of the three compartments housing the r.f. transformers, at the left hand end of the set looking at it from the front panel, has a single insulated wire passing through a hole in the side of the can, leading to the three gang condenser. As these wires are flexible, they can be threaded through the holes after the cans are in place. The same applies to the grid and plate wires of the oscillator condenser. These five wires are the only important ones which will have to be run after the compartment shields are assembled, and if the connection to the coil sockets in the compartments is made and soldered before the cans are set in place, the connections to the variable condensers can easily be made.

The antenna compensator is actually a trimmer whereby variations in antenna conditions can be taken care of without the use of a midjet condenser shunted across the section of the gang condenser which controls the first r.f. secondary. The compensator has a twin knob, the center part of which varies the inductance of a miniature variometer which is placed in series with the antenna tuned circuit secondary; the outside knob controls a three tap switch, whereby the antenna is either connected directly to the primary, or through capacities of .00010 or .00005 mfd. respectively. The two fixed condensers are mounted on the baseboard back of the compensator together with two binding posts for the antenna and ground. Directions for adjusting the compensator will be given in the instructions for tuning and operating the receiver.

A grid bias of $1\frac{1}{2}$ volts is required for the two shielded grid r.f. amplifier tubes, and this may be obtained either

by installing a single flashlight cell, or tapping off the battery used for *C* bias in the power tube circuit.

The oscillator condenser has a small balancing condenser of the variable mica type, fastened to the binding post terminals, so that the dial settings of the oscillator can be made to conform with those of the r.f. dial. This condenser is furnished with the No. 570 Interchangeable Inductance. Instructions for adjusting it will be given in the section on operating instructions.

All wiring of filaments, *B* voltage supply and *C* battery wires should be cabled, especially the leads from the cable plug terminal to the panel controls, and to the audio frequency amplifier, so as to present a neat appearance. Cabling a group of insulated wires is not difficult, and can be most easily done with waxed string, which is tied around the bunched wires every inch or so. Only the grid and plate wires, as well as the leads to the variable condensers and antenna compensator, need be separated from the cabling, so that there will be a minimum amount of loose wiring.

The usual precautions for testing the set after completion are particularly true in this case, as there are four expensive tubes whose burnout due to short circuits in the wiring would be costly. The most satisfactory way is to first test the filament circuit, placing a type 99 tube in each socket in turn, with the *A* battery connected, to see if the tube lights properly. Then connect the positive *A* battery to each positive *B* voltage wire in turn, testing the sockets with the 99 tube to see if the filament lights, or if any voltage indication is shown on the voltmeter. Should there be any indication of voltage in the latter case, there is a short circuit or high resistance leak from the positive *B* supply to the filament circuit, and it must be located before the batteries are actually connected. Even with the circuit completely tested

for continuity and freedom from shorts, a 25 watt mazda lamp should be connected in the negative *B* supply lead, and shunted with a 2 mfd. condenser, so as to guard against short circuits during the lining up process.

Place the tubes in their sockets, with the shielded grid tubes in the 1st and 2nd r.f. and 1st and 2nd i.f. sockets, CX-299 tubes in the mixer, oscillator, detector and 1st audio, and either a type 112 or 371 power tube in the power stage. With the type 112 tube and $157\frac{1}{2}$ volts plate, a $10\frac{1}{2}$ volt *C* battery should be used, and with the 371 tube, 135 volts plate and $22\frac{1}{2}$ volts *C* should be employed. If the latter tube is to be supplied with 180 volts plate and 40 volts *C*, an output transformer should be inserted between the loud speaker and the plate circuit of the tube, to protect the speaker from burnout.

Adjust the filament to 3.3 volts, by means of the rheostat on the panel underneath the voltmeter. This rheostat also acts as the filament switch, turning on the *A* battery circuit as soon as the knob is turned clockwise. Turn the sensitivity knob on the intermediate amplifier to about mid scale, and adjust the volume control resistance in the plate circuit of the r.f. amplifier tubes until a station can be heard when the tuning controls are moved back and forth. After a station has been located, bring it to resonance on both dials, and be especially careful to get the exact resonant point on the oscillator dial.

Now turn the antenna compensator center knob, which controls the inductance in the variometer, until the signal is at its maximum. Try the different taps on the outside knob of the compensator, in case the capacity in the series condenser is too small for the particular wavelength to which the set is tuned.

(Continued on page 50)

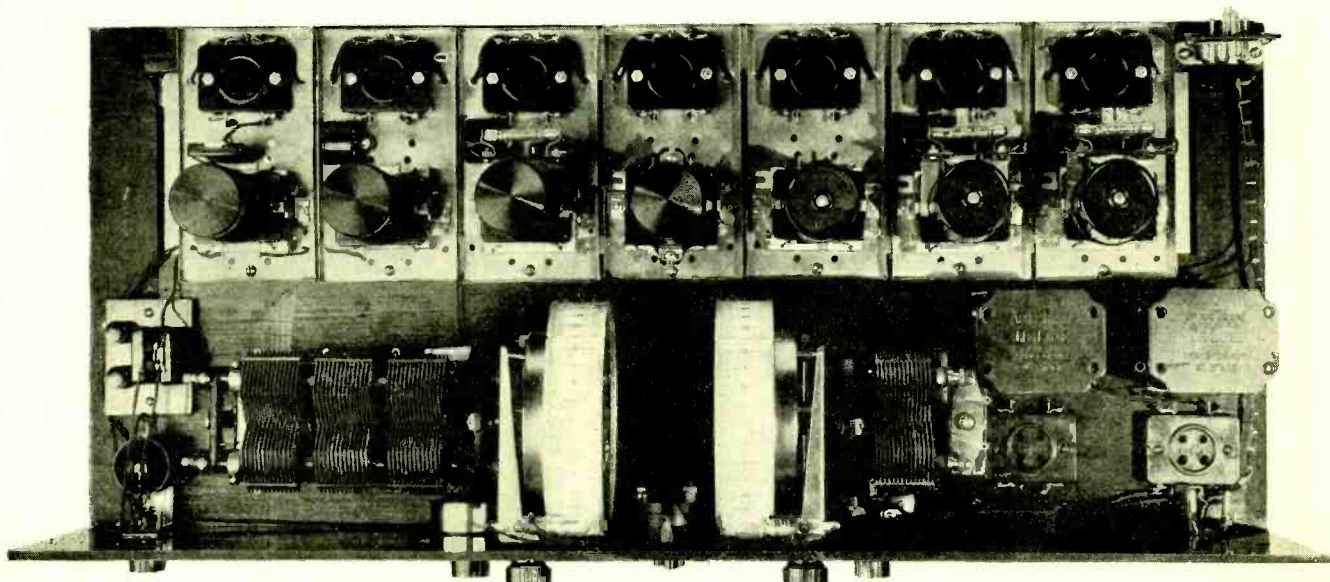

Top View of Superheterodyne.

The Transmission Unit

By Arthur Hobart

THE transmission unit, *TU*, is the engineer's basis for measuring the efficiency of an electrical circuit used in an electrical communication system. An audio amplifier, for instance, delivers more power at its output than it receives at its input. A resistance in a circuit causes a loss in power. The relative amount of power gain or loss is measured in *TU*.

Upon first thought, the natural basis of comparison should be the ratio of the output to the input. But experiments prove that the ear's response to sound energy is not in direct proportion to this ratio, but in proportion to its logarithm. The ear hears logarithmically.

Thus the sound energy from a full orchestra playing at its loudest is about one million times greater than when playing at its softest. But to the ear it sounds only sixty times louder. The ear's response is equal to ten times the logarithm of the power ratio. For a power ratio of 1,000,000 the logarithm is 6, and $10 \times 6 = 60$.

Consequently, telephone and radio engineers have adopted a "loudness scale" so chosen that the difference in loudness between two sounds is defined as ten times the common logarithm of their power ratio. This means that if the energy becomes 10 times greater, the loudness is increased by 10 *TU*—(log. 10=1, $10 \times 1 = 10$); if the intensity is multiplied by 100, the loudness is increased 20 times (log. 100=2, $10 \times 2 = 20$); if the intensity is increased by 1000, the loudness is increased 30 times (log. 1000=3, $10 \times 3 = 30$); etc. The number of times the loudness is increased is the number of *TU*.

So the transmission unit is seen to be a scientific as well as a practical basis for the measurement of sound intensity. In general, $TU = 10 \log (P_1/P_2)$, when (P_1/P_2) is the power ratio.

While the exact number of *TU* corresponding to any given power ratio can readily be figured by consulting a table of logarithms, the accompanying table from "The General Radio Experimenter" will be found to cover many cases which arise in practice. It gives, to the nearest 0.1 *TU* from 0.1 to 10 *TU* the corresponding power ratio for either gain or loss.

For power ratios greater than 10, if a gain, divide the power ratio by 10 and add 10 to the corresponding number of *TU*. Thus if the power ratio is a gain of 12, $12 \div 10 = 1.2$ for which the *TU* is .8; $.8 + 10 = 10.8$ *TU*. In case the

power ratio is greater than 10, for a loss, multiply the power ratio loss by 10 and add 10 to the corresponding number of *TU*.

For ratios less than 0.1, if a gain, subtract 10 from the number of *TU* gain and multiply the corresponding power ratio gain by 10. If a loss, subtract 10 from the number of *TU* loss and divide the corresponding power ratio loss by 10.

For those who are not familiar with the use of logarithms or cannot grasp the meaning of the table an approximate measure of the relation between power ratio and *TU* can be gained from the following table:

No. of TU	Power Gain	Ratio Loss	No. of TU	Power Gain	Ratio Loss
1	5/4	4/5	7	5	1/5
2	3/2	2/3	8	6	1/6
3	2	1/2	9	8	1/8
4	5/2	2/5	10	10	1/10
5	3	1/3	20	100	1/100
6	4	1/4	30	1000	1/1000

It will be noticed that the ratio for a gain of a given number of *TU* is the reciprocal of the ratio for a loss of the same number of units. Also for an increase of 3 in the number of *TU* the gain ratio is doubled and the loss ratio is halved.

As measurements of the gain or loss in a radio circuit are often in terms of current or voltage, and not of power, it

(Continued on page 50)

TABLE OF T. U. GAIN OR LOSS

No. of TU	Power Ratio		No. of TU	Power Ratio	
	Gain	Loss		Gain	Loss
0.1	1.023	.977	5.3	3.39	.295
0.2	1.047	.955	5.4	3.47	.288
0.3	1.072	.933	5.5	3.55	.282
0.4	1.096	.912	5.6	3.63	.275
0.5	1.122	.891	5.7	3.72	.269
0.6	1.148	.871	5.8	3.80	.263
0.7	1.175	.851	5.9	3.89	.257
0.8	1.202	.832	6.0	3.98	.251
0.9	1.230	.813	6.1	4.07	.245
1.0	1.259	.794	6.2	4.17	.240
1.1	1.288	.776	6.3	4.27	.234
1.2	1.318	.759	6.4	4.37	.229
1.3	1.349	.741	6.5	4.47	.224
1.4	1.380	.724	6.6	4.57	.219
1.5	1.413	.708	6.7	4.68	.214
1.6	1.445	.692	6.8	4.79	.209
1.7	1.479	.676	6.9	4.90	.204
1.8	1.514	.661	7.0	5.01	.200
1.9	1.549	.645	7.1	5.13	.195
2.0	1.585	.631	7.2	5.25	.191
2.1	1.622	.617	7.3	5.37	.186
2.2	1.660	.603	7.4	5.50	.182
2.3	1.698	.589	7.5	5.62	.178
2.4	1.738	.575	7.6	5.75	.174
2.5	1.778	.562	7.7	5.89	.170
2.6	1.820	.550	7.8	6.03	.166
2.7	1.862	.537	7.9	6.17	.162
2.8	1.906	.525	8.0	6.31	.158
2.9	1.950	.513	8.1	6.45	.155
3.0	1.995	.501	8.2	6.61	.151
3.1	2.04	.490	8.3	6.76	.148
3.2	2.09	.479	8.4	6.92	.144
3.3	2.14	.468	8.5	7.08	.141
3.4	2.19	.457	8.6	7.24	.138
3.5	2.24	.447	8.7	7.41	.135
3.6	2.29	.437	8.8	7.59	.132
3.7	2.34	.427	8.9	7.76	.129
3.8	2.40	.417	9.0	7.94	.126
4.1	2.57	.389	9.1	8.13	.123
4.2	2.63	.380	9.2	8.32	.120
4.3	2.69	.372	9.3	8.51	.118
4.4	2.75	.363	9.4	8.71	.115
4.5	2.82	.355	9.5	8.91	.112
4.6	2.88	.347	9.6	9.12	.110
3.9	2.45	.407	9.7	9.33	.107
4.0	2.51	.398	9.8	9.55	.105
4.7	2.95	.339	9.9	9.77	.102
4.8	3.02	.331	10.0	10.00	.100
4.9	3.09	.324	20.0	100	.01
5.0	3.16	.316	30.0	1,000	.001
5.1	3.24	.309	40.0	10,000	.0001
5.2	3.31	.302	50.0	100,000	.00001
			60.0	1,000,000	.000001

Better Loudspeakers

Practical Directions for Improving Their Tone Quality and A Comparison of the Magnetic and Electrodynamic Types

By Alan Donaldson

AS most loudspeakers give their best reproduction for sound frequencies between 300 and 3000 cycles and are deficient in volume for tones below and above these limits, there are two obvious plans for improving the quality of the music or speech. One is to bring up the low and the high notes to a volume approaching that of the middle register. The other is to reduce the volume of the middle register to a value approaching that of the low and high notes.

The former plan can be applied by redesigning the speaker but cannot well be applied to existing speakers. The latter plan can be applied by putting an equalizer in the audio amplifier so that it will reduce the energy of the middle frequencies and supply more energy at the low and high frequencies, where the speaker is weak. Any resulting sacrifice in normal volume can be compensated for by turning up the volume control on the receiver.

The magnitude of this speaker weakness is indicated by the curves in Fig. 1 which show the response of several well known cone speakers to various audio frequencies. It will be noticed that all of them show numerous peaks and depressions throughout the entire range of frequencies from 60 to 5000 cycles. But these peaks and valleys are

so sharp that most musical instruments are reproduced well enough to be recognizable. The tone deficiencies are noticeable only below about 300 and above about 3000 cycles. So if the middle register can be decreased in amplitude the music or speech will sound much more like the original.

The simplest method of lowering the middle band of frequencies is to use a resonant circuit shunted across the primary of some audio frequency transformer. The loss caused by this equalizer is greatest at resonance since only the resistance is then effective as a shunt across the circuit. At higher frequencies the inductance presents an increasing impedance which causes less loss, while the condenser does the same for the low frequencies.

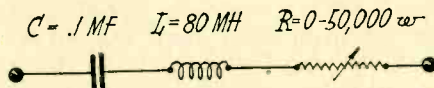

Fig. 2. Equalizer Circuit.

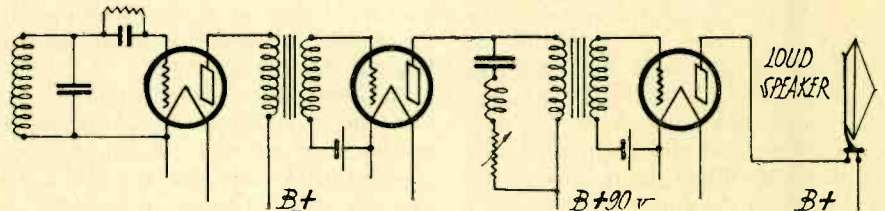

Fig. 3. Circuit Diagram of Equalizer in A. F. Circuit.

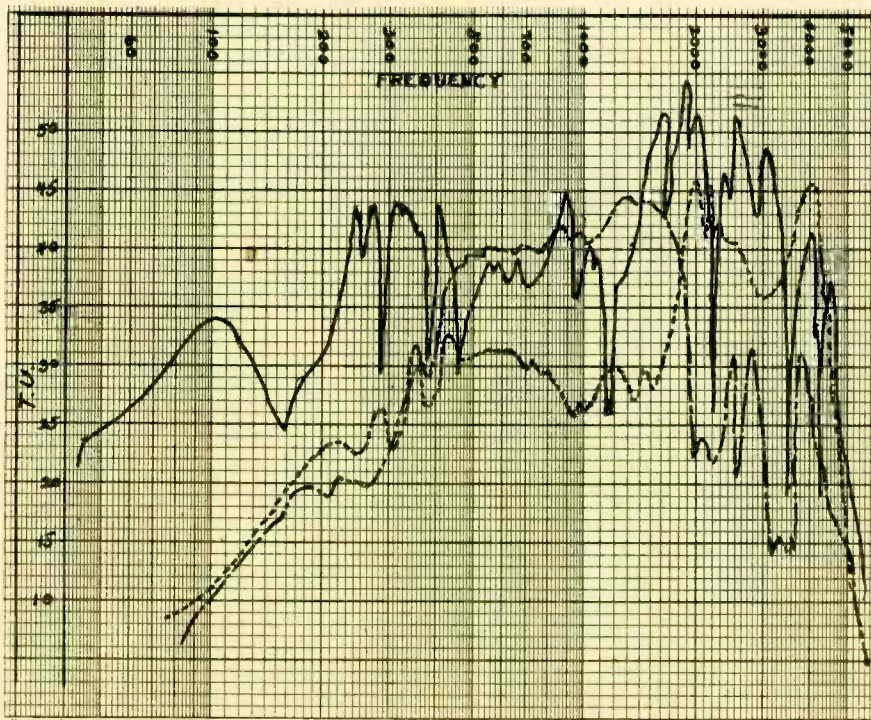

Fig. 1. Variation of Delivery Energy With Change in Frequency for Various Loudspeakers.

The circuit for such an equalizer, as shown in Fig. 2, consists of a condenser, an inductance and a variable resistance all in series. The value of the resistance determines the amount of loss caused by the equalizer and also the sharpness of the depression. Thus it can be made to cause a loss over a band of two or three thousand cycles and practically no loss at the ends of the band considered.

The equalizer can be made up of a 0.1 mfd. condenser, a 0-25,000 or 0-50,000 ohm variable resistance, and an 80 millihenry choke. The 0.1 mfd. condenser can be of the ordinary by-pass variety. The variable resistance may be a type H Royalty Electrad resistance, or a Centralab or Frost 0-50,000 ohm variable resistor. The Samson No. 85 radio frequency choke has an inductance of 80 millihenries so is quite satisfactory for this purpose, and was the one used in the experimental equalizer. The combination of a 80 millihenry choke and a 0.1 mfd. condenser, gives a resonant fre-

quency of about 1800 cycles per second at which frequency the equalizer loss will be a maximum.

These three units, resistor, condenser and coil can be mounted in a small box with a couple of binding posts for connection as shown in Fig. 3. The resistor should be set at such a value as to give the most pleasing quality of music to the listeners when the receiver is tuned to some good broadcast station.

The variable resistance allows this equalizer to be used with practically any audio amplifier, though of course the amplifier should be capable of reproducing both the high and low notes as well as the middle of the audio frequency band. In case the equalizer is to be used with a resistance coupled amplifier, the variable resistance should be of 0-50,000 ohms at least. With the ordinary cone speaker, and good transformer coupled amplifier the setting for the variable resistance will generally be between 5000 and 10,000 ohms.

This equalizer will not fit all cones, some of them being too poor for improvement by this means. If the manu-

facturers could be persuaded to publish characteristic curves of their speakers, better equalizers could be designed. Most of the better type of magnetic drive cone speakers are suitable for use with an "equalized" amplifier for bettering the quality. Some of the cheaper cones are not nearly as good as the average small horn speaker, but even so the quality is helped by using one of these equalizers.

The equalizer can be connected across the primary of either the first or second stage audio transformer as shown in Fig. 3, or can be connected directly to the plate and filament terminals of the detector or first audio tube. In both cases it is generally better to connect it across the amplifier tube or transformer terminals and not get it into the detector plate circuit where the plate impedance is usually pretty high.

There are two general types of speakers, the electrodynamic, consisting of a moving coil in a separately excited electro magnetic field; and the magnetic type, consisting of an iron armature in a magnetic field produced by a permanent magnet. The magnetic type has a moving iron armature in the field of a permanent magnet so there must be an elastic restoring force to keep the armature centered between the pole pieces. The electromagnet, which is energized by the signal, changes the flux density between the pole faces and so causes the armature to vibrate. This motion is transmitted through a system of levers to a diaphragm. A strong signal may cause enough flux to saturate the pole faces of the magnet and so produce serious distortion. When the pole faces become saturated the force is no longer a proportional function of the signal so the note or tone is not reproduced in proportion to the rest of the speech or music by the right amount. The need for a large elastic restoring force, with its attendant distortion and lack of sensitivity, may be reduced by using a weaker magnet or greater air gap or using a lever system which will hold the armature centered and also give the diaphragm greater or less motion than the armature at the pole faces. All of these levers and the driving rod in a cone speaker cause resonant bumps and depressions due to these causes.

Another item in an ordinary cone speaker is a driving rod which works in the direction of an arc instead of a straight plunger motion that should be imparted to the apex of a cone. If the driving rod is long enough the sidewise whip motion may be a major source of power to the cone.

As against all these faults of the magnetic type of driving unit, the moving coil or dynamic type has only a few faults, the main ones to most people being the cost and the fact that the field

winding has to be separately excited from a battery or some such arrangement. The moving coil type generally has a small plunger type cone with some sort of baffle. This cone has to be supported at the front edge and at the apex. But these supports can be made extremely flexible and of such a low natural period that no distortion is noticeable from this source. By having such flexible supports, very large amplitude of motion is possible and so the low notes have a chance to be reproduced. The elastic restoring force is low, that is, the cone is free to move in a horizontal direction, so no sacrifice in sensitivity is necessary.

Saturation, one of the bugbears of the magnetic type, has no chance to cause distortion in the dynamic type because it has no small pole faces and the signal energy does not act to change the airgap flux density, as it does in the magnetic type. The signal energy acts to produce a force tending to push or pull the moving coil if the coil is in a magnetic field. By having an intense magnetic field, the sensitivity can be made very great. The coil can move a relatively long distance, a tenth of an inch or so for low note reproduction, and still maintain a linear relation between the signal energy and the force. The magnetic type can not allow much motion of the armature or the proportion of change of airgap length to the average length becomes great with attendant distortion.

An interesting experiment is to put a low tone, anything below 200 cycles per second from an audio oscillator, into a good magnetic cone and then into a good dynamic cone. The sound from the dynamic will be low and pure with a pleasing boom while that from the magnetic type will be rather nasal even though it may sound fairly loud. This is due to

the fact that the dynamic cone actually reproduces the low notes while the other does not. The magnetic produces a lot of harmonics of the low frequency and it is these harmonics, and perhaps the beat notes between them, that are heard. So it is no wonder that they sound rather nasal. See if you can readily tell the difference between a bass viol, a tuba and drums in an orchestra selection from a good radio station. The difference between the dynamic and the magnetic types for this purpose is really astounding even when a three foot cone is used.

Diaphragms may be classed in several ways, the main two being the inertia controlled and the wave action types. The wave action type is the most familiar as it is used in the ordinary cone speakers where the force is applied at the center of a shallow cone. Flexural waves radiate towards the outer edge and so the attenuation must be fairly large or reflection will take place from the outer edges of the cone. This causes a myriad of resonant peaks as can be readily seen in curve A of Fig. 4. This curve was the best of any of those taken of the magnetic type speakers. If the paper cone is too heavy in texture or supported at the edges too rigidly, there is too much energy loss and consequent lack of sensitivity.

The inertia controlled diaphragm is one in which the driving force acts only to move the mass of the diaphragm. One form of this diaphragm is used in the dynamic speaker in which a small cone is driven as a plunger. The nearer this angle approaches 45 degrees (90 degrees solid angle) the more rigid it is and the more nearly it acts like a pure plunger diaphragm. Even so, the effect of resonant bumps becomes noticeable as is shown in curve B of Fig. 4. These res-

(Continued on page 48)

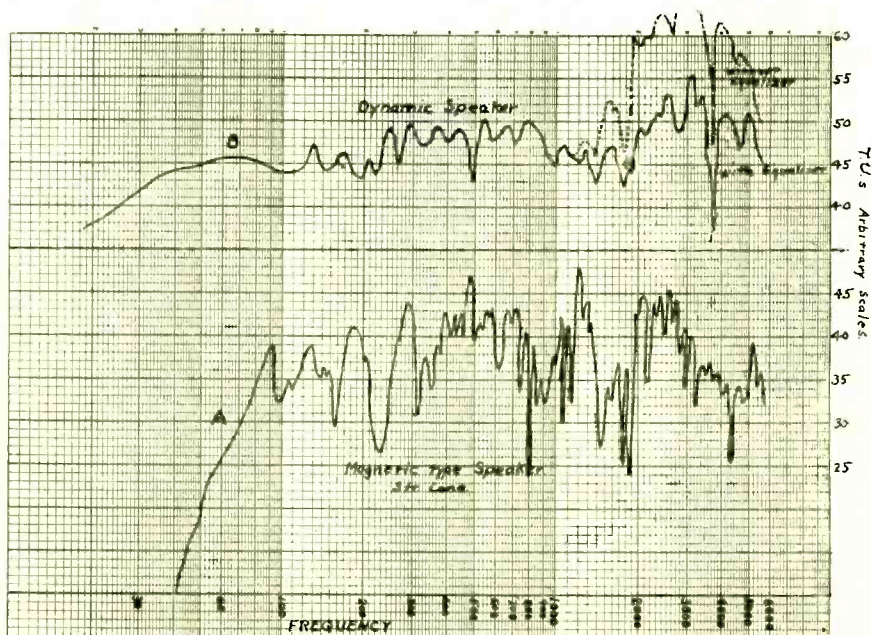

Fig. 4. Response Curves of Typical Dynamic and Magnetic Speakers.



"Abie announced that the transmitter was ready."

W
ANDREW

S O S

By Armstrong Perry

"UNLESS something is done the election is lost."

"You said a mouthful!"

"Then we'll find out what that something is, and do it!"

Minelli, Goldberg and Casey looked at each other intently across the table in the private office at campaign headquarters.

"They've got a clear hundred thousand majority north of the river, the election is Tuesday, and it's Saturday now—there's only two days left."

"The state committee is in the hole so deep now that it will never get out and half a million dollars' worth of printed matter and postage wouldn't turn the tide."

"Oh, I don't know. Look what the gang did to Pinchot, over in Pennsylvania. The Saturday night before the election they assured him that there would be no contest for his place as a delegate to the national convention. Governors always had been elected delegates at large, as a matter of courtesy. There was nothing in the job, only the prestige. He never thought anybody would spend money to get that job when there were so many good ones to try for. But that night they kept printing presses running under cover and mailed from Philadelphia a million letters stating that Governor Pinchot had withdrawn and that a brewer would take his

place. The letters were not delivered until Monday, of course, and by the time the governor got wise it was too late to do anything."

"Why didn't he use the radio?" asked Minelli.

"Yes, he could have reached every voter in the state for a thousand dollars," exclaimed Goldberg.

"Not then, but we can now, and that's what we are going to do," said Casey.

All talked at once. Goldberg's voice rose above the babel: "But what about the opposition? Why couldn't they get the air after us and expose the trick? We can't buy up all the stations for the whole of Monday evening."

"We won't try to buy any of them, only in the regular way," said Casey. "We'll get half an hour on the ones everybody listens to because they have the best programs. Of course we won't try to tie them up for the whole evening—that would put everybody wise to the plan before it got started. What we want to do is to put our stuff across and then get all the stations shut down until the folks that listen get to bed."

"But how are you going to shut them all down?" asked Minelli.

"I don't know, but it happens," Casey replied. "Who knows a radio man who can give good advice and then keep his mouth shut?"

"Your boy knows a lot about radio,

Casey," suggested Goldberg.

"He's only an amateur," Casey answered. "We need a professional for this job."

"There's Abie Rosenbloom," said Goldberg, "he joined the Navy just before the draft. He got to be a radio operator and he's got a radio business now."

"Call him up and ask him to come here at once," said Casey.

Abie was ready to serve the party.

"What makes all the broadcasting stations shut down sometimes in the middle of a program?" Casey asked him.

"An SOS," said Abie.

"How does it work?"

"When a ship's sinking the old man tells his sparks to SOS. The SOS is picked up at the DCS headquarters in the nearest port. If the squeak box can't shoot far enough, some other tub relays the call. The DCS tells the broadcasters to QRT. They gotta do it or lose their tickets," was Abie's explanation.

"Say it in English," said Casey.

"A distress signal always has the right of way," explained Abie. "As soon as anyone hears an SOS they shoot it into the district communication headquarters of the Navy, or rather they broadcast it on a broad wave and it is picked up there. The super orders all transmitting

(Continued on page 51)

Experimental Shop Practice

How to Make a Thomson Galvanometer

By Samuel G. McMeen

NOW arises in his place in the audience Mr. Frank W. Reed, and enters complaint that we mentioned galvanometer mirrors in May, 1927, RADIO, but did not tell how to make them, and that we spoke of certain mica strips relative to the coil of the same device but did not tell how to attach them. We are contrite, and hasten to supply the omissions. Likewise we are grateful, for there is no straighter way to an author's heart than to admit that one has read his stuff.

To prepare a mirror for a galvanometer is a vastly better thing than to buy one already made, and besides, such mirrors are not as readily obtainable as are some other articles. The clean, clear joy of creation of such an accessory far outweighs the trouble of doing the work. It is done as follows:

Acquire a microscope cover glass. These are very thin round pieces of glass, usually measuring $\frac{5}{8}$ ths in. in diameter and .008 in. thick. Thus the glass is very light, which well fits it for use in any galvanometer.

Now to the silvering: Dissolve 70 grains of nitrate of silver in one fluid ounce of water. Add drops of ammonia until the brown precipitate which is formed on the addition of the ammonia is barely re-dissolved, but not entirely. Let the precipitate settle or filter it. Then add water to bring the volume of the solution to 16 ounces, fluid measure.

Now dissolve 16 grains of nitrate of silver in $\frac{1}{2}$ oz. of water and pour the resulting solution into a pint of boiling water. Then dissolve 12 grains of Rochelle salts in a small quantity of water and add to the boiling solution. Boil for half an hour, until a gray precipitate collects in the flask. The solution is then to be filtered hot and the volume made up to a quart. This is more than enough to silver a number of cover glasses, but the solution is useful for all kinds of glass silvering and it is not amiss to keep it on hand for such purposes. These two solutions will keep for one month or so, but may be used immediately.

To do the silvering, mix equal amounts of the two solutions, and pour over the cover glass, laid in a small glass dish or tray. Let the cover glass stay in the silvering solution one hour, to secure a heavy deposit. Then rinse it, let it dry, and remove the silver from one side, choosing the side that is least perfect in the deposit. This removal of

silver can be done by rubbing with crocus paper or crocus cloth, though this method has the disadvantage that one must be extraordinarily careful not to break the thin cover glass. Laying the glass on a very flat surface helps in this regard. The best way is to apply nitric acid with a pledget of absorbent cotton on a stick, which application will remove the silver instantly. Let none of the acid touch the other side of the piece. Then wash the glass and dry it. Apply a coat of varnish on the silvered back to preserve the coating against scratching.

The reflecting surface in this case is from the back of the glass. That is, the light to be reflected passes through the glass first, then is reflected from the front surface of the applied silver, then through the glass again, and so to the eye of the observer.

The cover glass thus silvered can well be attached to the hook that supports the moving coil by means of a Greek cross of thin metal, bent over the edges of the glass, the cross being attached to the hook by solder.

There are two methods by which the very slight motion of the coil can be observed. One is that of seeing the reflected image of a limb of an incandescent lamp directly on a screen or scale; in this case something is necessary to make the image of the lamp sharp, and so convex lenses are interposed between the source of light and the mirror, adjusted so that the limb of the lamp filament appears sharply on the scale. It will be well if this scale is a long one, with graduations $\frac{1}{4}$ in. apart.

A preferable method is to observe the image of a reversed, inverted scale in the mirror by means of a telescope. In this case the telescope is of the astronomical type, in which the lenses, objective and eyepiece, are both convex. Thus the image of anything seen by such a telescope is itself inverted, because of the nature of the lenses. With this one reversal and one inversion, the image comes out right-side-to and right-side-up. In this case of a scale viewed through a telescope, the scale, which is placed ahead of the telescope and requires to be well lighted, may well be 20 in. long by 2 in. wide.

Now as to Mr. Reed's other plaint. The mica strips support the hooks that poise the coil at top and bottom. They are approximately $\frac{5}{8}$ in. long by the

width of the coil. They are placed one within the coil and one without it, opposite to each other, the pin-hook which supports the coil on the silver wire piercing the outer mica slip. The two slips are then bound to the coil with a winding of fine silk thread at each end. Thus all is made secure when a layer of thick orange shellac has been painted over the silk thread. The hooks can conveniently be made of common pins, whose heads can be flattened with advantage.

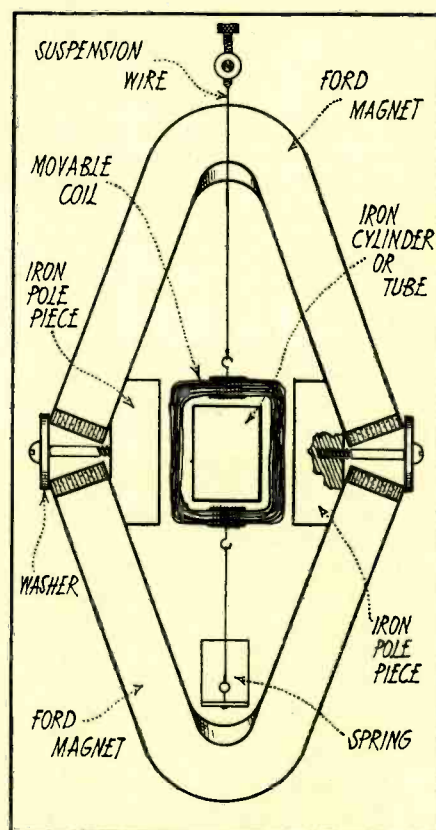

Fig. 1. Plan of Galvanometer.

The Thomson galvanometer consists of a coil of wire with a hollow in its center, in which hollow is suspended a mirror with magnets on the back. These magnets are made from pieces of the smallest watch springs, and are attached (by shellac) astatically; that is, assuming that there are four such small magnets, two of them shall have their north-seeking ends pointed in one direction across the back of the mirror and the other two shall have their south-seeking ends pointed in that same direction. Thus the tendency of the earth to direct the position of the mirror will be reduced to a minimum. Usually, in

(Continued on page 57)

Shielded Grid Tubes in the 1928 "Hi-Q"

By Francis Churchill

THE advent of the shielded grid tube for use in r.f. amplifiers offers new fields for the experimenter and set builder. The following description is given for those set builders who like to keep up to the last minute in receiver construction. The kit used was the 1928 Hammarlund-Roberts Hi-Q Six. It can be assembled to use the new tubes, or by a few minutes of re-wiring if it was originally wired as described in the construction manual that comes with the kit.

The shielded grid tube requires special precautions in order to give maximum efficiency. The amplification per stage is a great many times that of an ordinary r.f. amplifier, when connected in the proper tuned circuit, and if a thorough job of shielding is done, no trouble from oscillation will occur. The control-grid-to-plate capacity is extremely small so neutralizing is not necessary. But since the gain per stage is enormous, all feedback from the coils, condensers or wiring in the set must be eliminated if more than one stage is to be considered.

The really great advantages of this tube are not realized unless more than one stage is used, since a regenerative

gain may be quite enormous in a single stage of r.f. amplification. However, two or more stages of r.f. using ordinary tubes will give very little more gain than one regenerative stage and it is only by using three or four stages that good amplification is obtained. Two stages of the new shielded grid tubes will give as much, or more amplification in the broadcast band as will four stages using A tubes and without as much sideband cut-off resulting in loss of the higher musical notes. In fact two stages using these new tubes are enough to get down into the static and noise loud enough to paralyze the audio amplifier at times.

One of the peculiarities of the new tube is that the amplification depends on the product of the mutual conductance of the tube and the plate impedance of the load. Since the mutual conductance is a little less than that of an ordinary A tube, it is necessary to have a very high impedance in the plate load. This means that an ordinary r.f. transformer is useless with its untuned primary unless the primary has a large number of turns, nearly the same as the secondary.

The most convenient arrangement is to use only the secondary coil as an auto-

former of 1:1 ratio. Since the secondary is tuned by means of a variable condenser to the desired frequency, it offers a very high impedance, if an efficient coil is used, at that frequency. Since the B supply is fed through the coil to the plate, as shown in Fig. 1, a stopping condenser is necessary and a grid leak to keep the control grid at the proper negative potential. Since this grid leak is in shunt to the tuned circuit, it should be at least 2 megohms in value in order to keep the total external plate load impedance very high.

While the sensitivity is extremely fine in a set using these shielded grid tubes, the apparent selectivity is poor, so special circuits must be used. Since only two stages of r.f. amplification are used in the modified set, and the kit was originally made for three stages, the problem is quite easy to solve.

Even with the special arrangement shown in Fig. 1, the apparent selectivity is not great and so in the vicinity of a powerful broadcast station, it may be desirable to use an ordinary wavetrapp tuned to the undesired station. This wavetrapp may be made easily by using an ordinary r.f. transformer with the secondary shunted by a variable con-

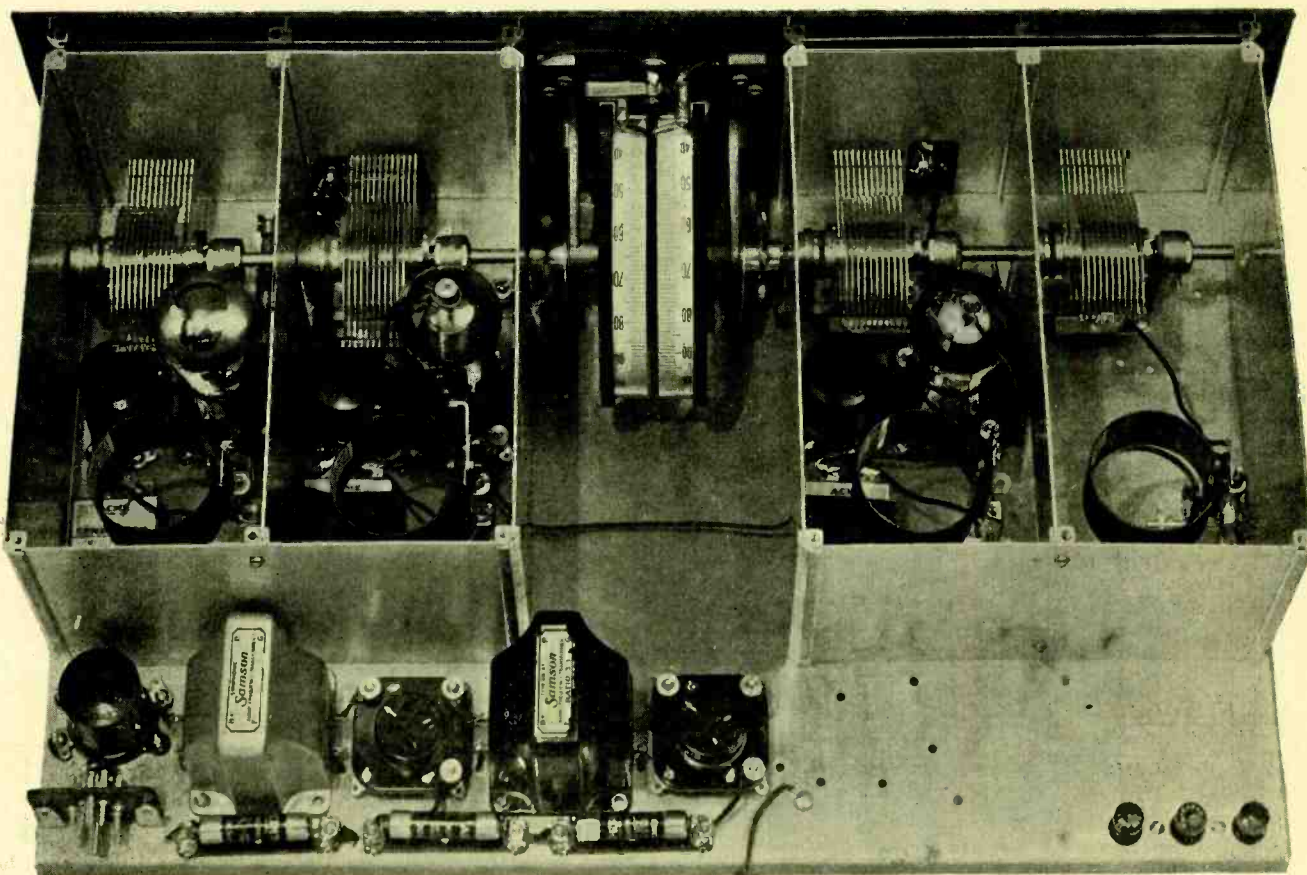

The 1928 "Hi-Q" with Shielded Grid Tubes

denser, and the primary in series with the antenna lead. The term "apparent selectivity" is used since the receiver is about as selective as an ordinary arrangement using three stages as in the Hi-Q Six. While it may have the same selectivity or even slightly more, still the sensitivity is equivalent to a four stage amplifier so the important ratio of selectivity to sensitivity is not maintained. These effects are noticeable only when tuning for distant stations through lots of local interference.

In constructing the receiver the construction manual can be followed closely with few exceptions. The cam shafts are unnecessary and the primaries of the r.f. transformers can be removed if one desires to make it as efficient as possible. The primary of the first transformer should be left on as it is used for antenna coupling and should be adjusted for best coupling for the particular antenna used and then held in place with a rubber band or a piece of string on the slider rod.

In mounting the equipment on the steel chassis, the first socket should be left out, and two by-pass condensers taped together and mounted as per manual of instructions for each of the two middle compartments. These two additional by-pass condensers are necessary since the shielding grids should be grounded through these to the receiver shields.

All of the battery wiring is the same as in the Hi-Q Six except that different size filament resistances are used in the r.f. tubes since these tubes are made to operate on 3.3 volts or less. It is quite important that the 20 ohm resistances be substituted as shown in Fig. 1 in order to safeguard these r.f. tubes and they should be center-tapped for grid return in order to give a negative bias of about 1.5 volts to the control grid, which is the fifth terminal. Contact to this can be made by a small clip or by tightly twisted flexible wire wound several times around the cap on top of the tube.

- LIST OF PARTS**
- 1—Samson Symphonic transformer
 - 1—Samson transformer HW-A3
 - 4—Hammarlund .0005 Midline condensers
 - 4—Hammarlund Hi-Q Six auto couple coils
 - 4—Hammarlund r.f. chokes RFC-85
 - 1—Hammarlund Illuminated drum dial
 - 5—Benjamin Cle-Ra-Tone sockets
 - 2—Amperites No. 1A
 - 1—Amperite No. 112
 - 5—Parvult ½ mfd. series A bypass condensers
 - 1—Carter No. 1R-20 "Imp" rheostat
 - 1—Carter No. 2A "Imp" battery switch
 - 1—Sangamo .001 fixed mica condenser
 - 1—Sangamo .0005 fixed mica condenser
 - 1—Sangamo .0025 fixed mica condenser
 - 1—Grid leak mounting
 - 2—Durham metallized resistors, 2 megohm
 - 1—Yaxley No. 660 cable connector and cable
 - 3—Eby engraved binding posts
 - 1—Hi-Q Six foundation unit
 - 2—Carter 20 ohm fixed resistances

Since there are no additional holes to drill in the steel chassis or the panel, the assembly of parts and wiring, following Fig. 1 closely, should not take more than one or two evenings.

The volume control rheostat should be the type used in the kit and of the model IR-20 with no brass reinforcement strip on the contact arm. This rheostat should be of 20 ohms, instead of the 6 ohm type furnished, in order to obtain the same volume control.

The special grid lead resistances are unnecessary and ordinary wire should be used throughout unless trouble is had with oscillation due to proximity of leads in the shielded grid stages, in which case one grid lead of the special type supplied with the kit will be sufficient. The wiring changes from the original Hi-Q Six are not complex and a person should be able to follow the wiring diagram in Fig. 1. Direct point to point wiring should be used and wherever any soldered connections between wires are made, the joints should be taped to prevent short-circuits. The battery cable leads can be wired exactly as shown in the manual but an extra flexible lead should be run out to the battery from the r.f. tube plate circuits. This extra lead from the two r.f. choke coils L_2 and L_3 should connect into either plus 135 or plus 90 volt tap of the B supply. 90 volts on the plates of the two r.f.

tubes will give nearly as good results as 135 and is generally available when using a B power unit.

If any trouble is observed from oscillation in the r.f. amplifier, the plate lead from the socket to the coil in the next shielded compartment can be shielded with flexible tubing. Anything such as a grid leak mounting, should be at least 2 in. away from the plate binding post on the tube socket so as to keep the control-grid-to-plate capacity at a minimum. If more than two stages of these shielded grid tubes were used, complete shielding of all leads and even of the tubes themselves, would be necessary.

Reference in Fig. 1 will show that a special tuned circuit is used between the antenna and the first r.f. amplifier. The only coupling between the first tuned coil and the r.f. tuned grid coil is inductive between these two tuned coils. In order that there may be some coupling it is necessary to saw or cut out a piece of the interstage shield. A square of about 2 in. should be cut out of the lower back corner of this sheet before it is slipped into place. If in the finished receiver, slightly greater sensitivity at the expense of selectivity is desirable, a larger square may be cut so as to allow more coupling.

After the receiver is completed, and checked for correctness in wiring, it should be put into operation by tuning in some fairly distant station. The rotors of the condensers should be loosened slightly on the shafts and moved back and forth for loudest signal strength. If, after clamping the rotors, they are slightly out of line, balancing or trimmer condensers should be connected across those condensers which have the rotors turned into the stator plates the farthest. The small Hammarlund neutralizing condenser is convenient for this purpose and it will generally be found desirable to have one across C_3 , the third tuning condenser. Due to the fact that the effective input capacity of the shielded grid tube is very low, this is the only trimmer condenser necessary.

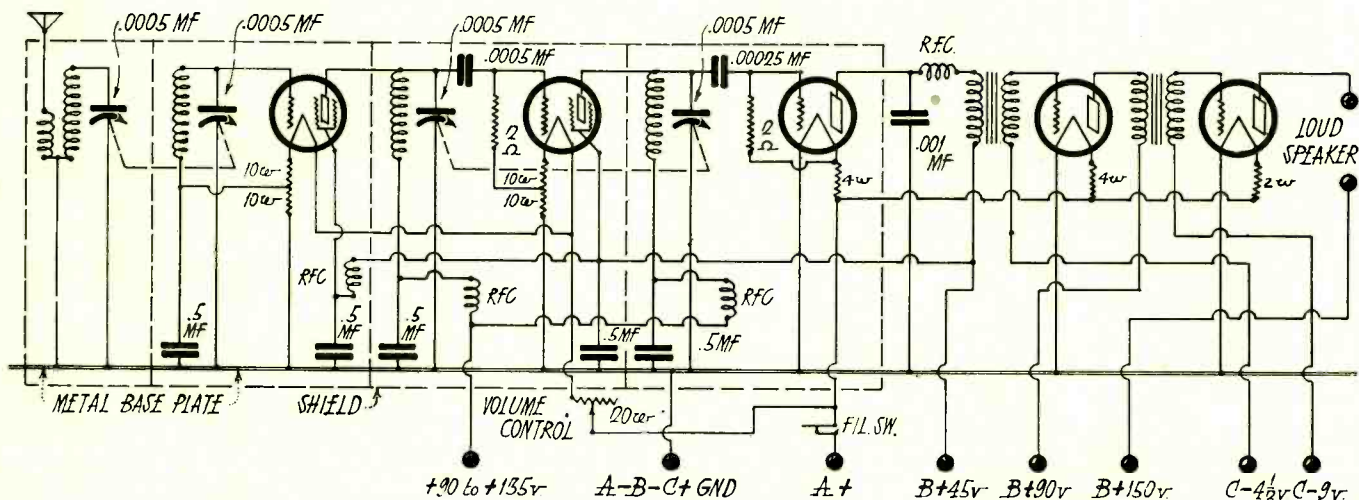

Fig. 1. Circuit Diagram of 1928 "Hi-Q" Adapted for Shielded Grid Tubes.

The Perfam AC-4

Directions for Constructing A Low Cost Receiver Using Four A. C. Filament Tubes

By Perry S. Graffam

THE Perfam AC-4 is presented to show the application of various improvements in radio design, including the use of a.c. filament tubes. This receiver is low in cost, uses a familiar circuit of one r.f. and detector and two audio stages of high quality amplification.



Panel View of Perfam A.C. 4.

Of the different a.c. tubes the author has chosen "Sovereign" heater type. The alternating current from the house supply, normally 110 volts, 60 cycles, is applied to a step down transformer which reduces to approximately 3 volts. The tube's heater unit is then connected across the 3 volts in multiple as shown in sketch of transformer and tubes.

When alternating current flows through the heater element it heats up a special cathode which emits electrons and acts like an ordinary filament. A low resistance power rheostat is connected in series with the step down transformer to regulate the a.c. voltage. The "Sovereign" tube is claimed to have a normal life of 1500 hours and is operated at a comparatively low temperature.

When the r.f. circuit is properly neutralized the circuit is more stable. For that reason a Phasatrol is used to eliminate tendency toward radio frequency oscillation or distortion.

The tuning coils are the Birnbach r.f. No. 60 and Birnbach No. 60 tuner. These coils, when tuned with Amsco .0005 condensers, will cover the broadcast range of 200 to 550 meters. An outside or inside antenna may be used and no shielding is necessary although the step down transformer is mounted on the sub-panel directly in back of the r.f. tuning unit. Another new feature, but no additional expense, is the use of S-M drum dials. They present a neat appearance, are easy to tune, and allow more room behind the front panel as the condensers are mounted on a horizontal plane. The dials may be illuminated by connecting the dial light socket to the a.c. line for the tubes.

In a receiver operated from a.c. it is always necessary to employ some method of controlling the volume, as the usual method of turning down the filaments in a receiver will not suffice for this type of tube. A universal range Clarostat is connected across the grid and grid return of the first audio transformer. This is a satisfactory method and controls the volume from a whisper to full tones.

Before starting the actual assembly of the receiver, each part should be examined with the utmost care to make sure that it has suffered no damage in transit or handling before being received by the builder.

The layout and circuit drawings

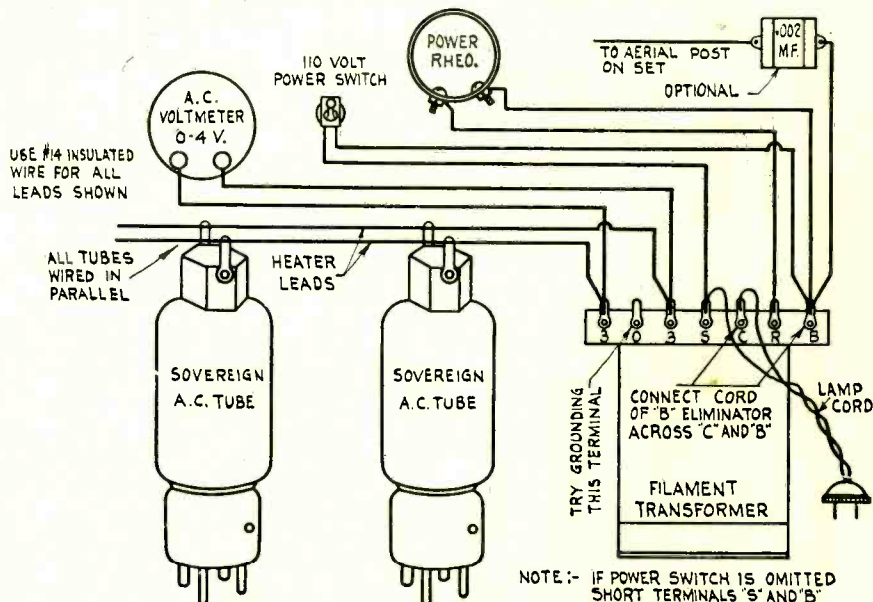

A.C. Filament Circuit Diagram.

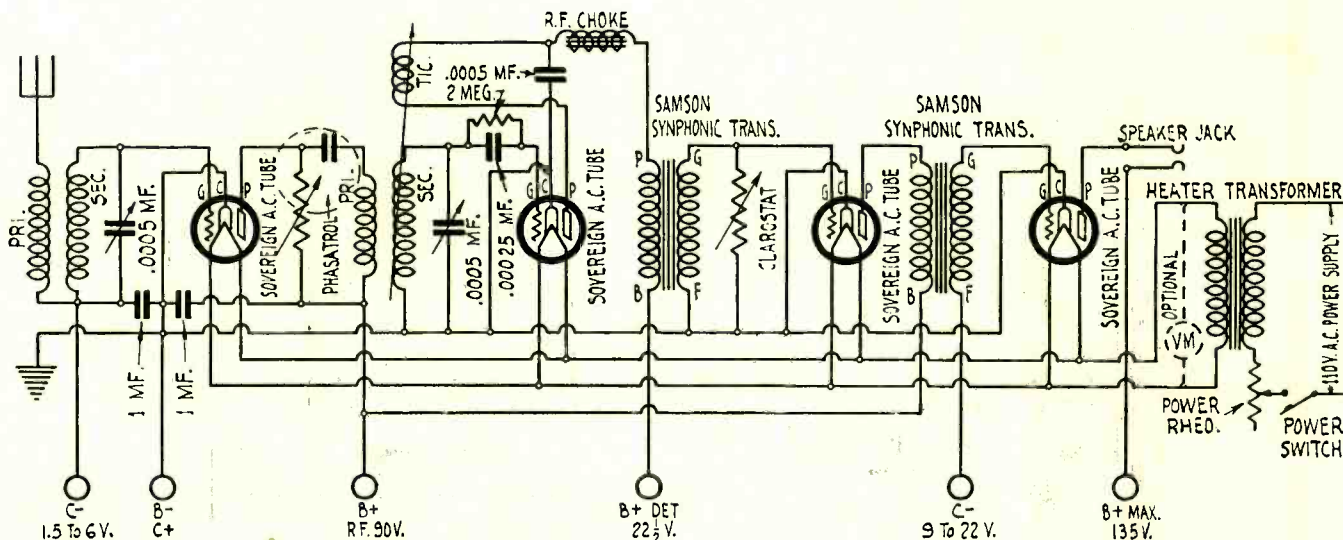

Circuit Diagram of Perfam A.C. 4.

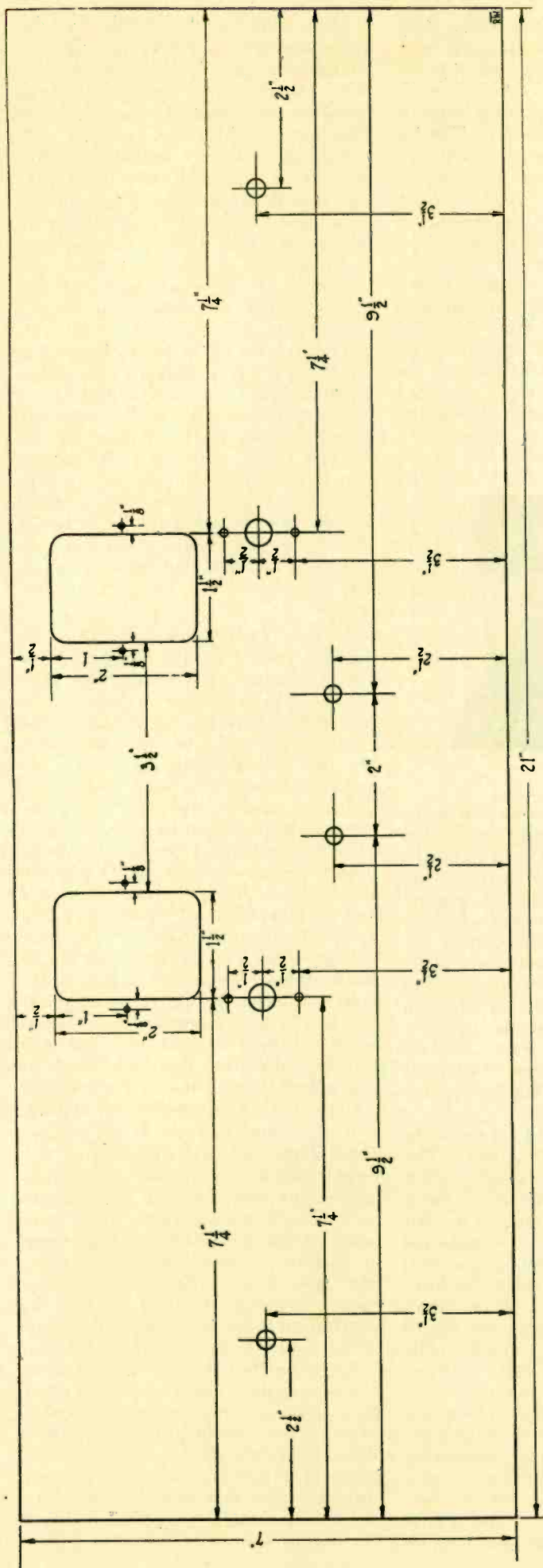

Panel Drilling for Perfam A.C. 4.

LIST OF PARTS FOR
PERFAM A.C.-4

- 1—Birnbach No. 60 tuner
- 1—Birnbach No. 60 r.f. coil
- 4—Sovereign A.C. tubes

- 1—Sovereign heater transformer, power switch and power rheostat
- 2—Tobe Deutschmann No. 3001-1-mfd. condensers, 1 2-meg. grid leak and grid condenser (.00025 mfd.)
- 1—T. D. .002 mfd. condenser.

- 1—Pr. Silver Marshall No. 540 mounting brackets.
- 1—No. 275 Silver Marshall r.f. choke coil
- 2—Anaco No. 526 variable condensers (.0005 mfd.)
- 2—Samson Symphonic audio transformers
- 1—Jewell No. 190 a.c. voltmeter (0-5 volts)

- 4—Tube sockets
- 1—Phasatrol
- 1—Yaxley cable plug
- 50 ft. Celatsite hook-up wire
- 1—Formica panel, 7x21x3/16 in. and sub-panel, 9x20x3/16 in.

should be studied for all important points. The front panel should be laid out first as the drilling for the drum dials require quite a few additional holes. Particular care should be used in following the instructions which accompany each dial, a correct template is also enclosed. The other parts require only one hole each and are easy to mount. After arranging the front panel, this may be laid to one side while the sub-panel is laid out, due care being taken that the apparatus on both panels when placed together, do not overlap.

Wiring is quite simple. Flexible wire such as Acme Celatsite which comes in colors should be used, the various colors serving for identification purposes. Also with such wire, the danger of closed loops and other causes of feed back as with bus-bar wire is eliminated. Small holes should be drilled in the sub-panel near the terminals of the various parts, to permit connections from underneath the panel to object assembled above.

All grid and plate connections from tube sockets to their connecting terminals on coils and condensers, should be made above the sub-panel. By referring to the pictorial diagram, the heavy black leads are above the sub-panel, while those shown dotted are below; apparatus mounted on the underside of sub-panel is also shown dotted.

All leads should, of course, be as short as possible. The wiring for the grid returns should lead to one side of the socket marked —F. As there may be some confusion at this point, the two F posts on the socket may be connected together. This is a sure way and no harm will result as one of the posts is dead at all times. As the two wires which run to the power switch have alternating current flowing through them, it is better to enclose these two leads in flexible metal tubing such as Belden's 1/4 in. copper tubing.

The wiring for the filaments is shown in the separate sketch for tubes and transformers. Loops should be placed in the wires to allow sufficient slack in case it is desired to change a tube. The lead to the house supply should leave the set as near the transformer as possible, as these wires carry 110 volts a.c. The connecting cord should be standard rubber covered and approved by the Board of Fire Underwriters for such purposes. All other connections to the "B" supply are made with the Yaxley cable plug. It is easily seen how quickly a set can be disconnected should it be desired to move it, only two operations being required.

Assuming that all the connections have been made correctly, connect the "B" battery or current supply to its respective leads in cable. The r.f. should have from 67 1/2 to 90 volts, while the detector battery should be near 45 volts, while up to 180 volts may be used for

the audio. Connect the antenna and ground. In some cases the receiver will operate without an antenna by putting a .002 mfd. condenser between aerial post and point *B* on filament transformer. However, when the antenna is used, the .002 mfd. condenser should be disconnected.

The set is now ready for testing and operation. Attach the cord from transformer to house supply. Connect the speaker to proper posts. No sounds will be heard from 12 to 20 seconds as the heater unit requires a certain amount of time to heat. After waiting the necessary interval, tune the receiver in the regular manner; having tuned in a station—preferably one of the locals, advance the tickler coil until a squeal is heard. By rotating the antenna coil condenser, the squeal will vary in pitch and

tion on a nearby receiver when some other station is tuned in. It is different from broadness of tuning and may be distinguished by the fact that it is audible only when another carrier wave is passing through the amplifier. The interference rides on the second carrier.

Feed-through is caused by over-excitation of the first tube in an amplifier which depends upon a succession of tuned circuits for its selectivity. The powerful impulses on the grid of the first tube swing it past the range within which the output is directly proportional to the input—the so-called “straight line portion of the tube characteristic.” The extent to which the signal on another carrier is amplified depends upon the extent to which the grid is being swung by the first signal.

In other words, after it has passed

More effective than either of the above remedies is tuning the antenna, although this involves an additional control. The method is to insert a variometer in the antenna circuit. It works best on sets which are equipped with “long” and “short” antenna binding posts or an equivalent switch. In using the variometer, use the long antenna connection. It should be noted that for best results with a tuned antenna circuit the coupling between antenna and the tuned circuit which feeds the first tube should be of smaller value than is usually provided.

The addition of the tuning variometer involves a complete change in set design. It often works very well indeed, but it may not work at all, and if it does fail, remember that if the designer of the set had really meant it to be used in that fashion he would have included the variometer himself. Since the addition is really an alteration in the design of the set to meet special conditions, its success or failure is contingent upon factors which should not be charged to the designer.

There is another line of attack which does not involve cutting down the input energy, though it, too, requires tampering with the design of the set. As was stated, feed-through results from swinging the grid past the point where the tube characteristic is linear. In audio amplifiers this same thing gives distortion, and in audio amplifiers we remedy the distortion by using a higher plate voltage and a proper *C* battery. Many sets use 45 volts on the plate of the r.f. tubes and no *C* bias, or else a 1 volt *C* bias obtained from the drop across the filament rheostat. The same voltage conditions as are used in the audio stages—90 volts *B* and 3 to 5½ volts *C* (including the rheostat drop) will give a longer portion of the characteristic curve to work on, and will usually raise the threshold level at which feed-through occurs from 100 to 500 per cent—a gain well worth making.

In this connection one should not lose sight of the fact that the use of a filament rheostat as a volume control usually means that the grid bias changes with the filament current. This may cause modulation within a certain range of rheostat settings. The same effect may arise from cutting down the filament temperature to a point where the electron emission is insufficient for the demands of the plate, so that saturation value is reached before the grid completes its swing. These two effects offset each other to some extent, but either may cause modulating conditions. Where feed-through is apt to occur, it is better that the grid bias and filament current of the first tube be fixed once and for all at the proper value, and that the volume control be relegated to the second tube.

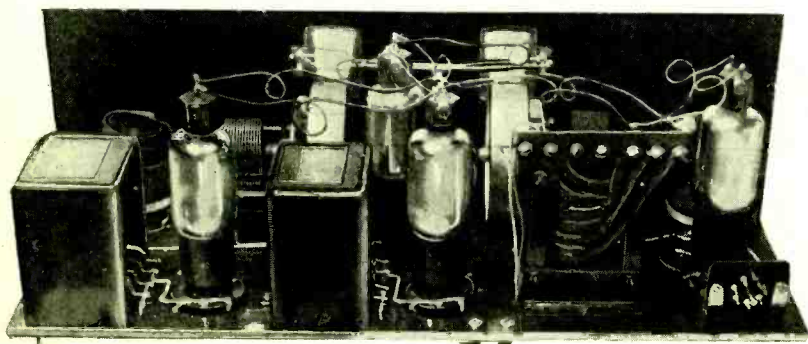

Rear View of Perfam A.C. 4.

intensity, if the set is not neutralized. By adjusting the position of the Phasatrol, the squeal can be brought to a point where it will vary only in intensity—not in pitch. This is the point where neutralization is obtained. If the builder has an a.c. voltmeter reading from zero to 5 volts, the greater life of the tubes and maximum efficiency can be obtained when the voltage to the tubes is set at 3 volts. This voltage is regulated by the power rheostat on the front panel.

These tubes will not operate from direct current and if the set is connected to d.c. even for a short space of time, the transformers will be ruined.

When using the set, if a hum is produced, be sure *O* on the transformer is grounded, also try changing the detector tube. A tube that gives a hum as a detector, will work satisfactorily as an amplifier.

To test for burnt out tubes, remove one of the wires to the heater terminals and make and break their connections. A slight movement on the voltmeter when this is done is an indication that the tube is good. After a little experience in operating the set gratifying results will be obtained.

FEED-THROUGH

By Donald K. Lippincott

“Feed-through” is a form of radio interference produced by a powerful sta-

tion on a nearby receiver when some other station is tuned in. It is different from broadness of tuning and may be distinguished by the fact that it is audible only when another carrier wave is passing through the amplifier. The interference rides on the second carrier.

Feed-through is caused by over-excitation of the first tube in an amplifier which depends upon a succession of tuned circuits for its selectivity. The powerful impulses on the grid of the first tube swing it past the range within which the output is directly proportional to the input—the so-called “straight line portion of the tube characteristic.” The extent to which the signal on another carrier is amplified depends upon the extent to which the grid is being swung by the first signal.

In other words, after it has passed

the first tube, the carrier to which the set is tuned is just as truly modulated by the interfering signal as it is by the one it is supposed to be carrying, and when this occurs no amount of selectivity will eliminate it. In the ordinary case of interference we are trying to separate an interfering wave from a desired wave of different frequency, but in this case we are trying to separate an interfering signal carried on the same wave as the signal we want, and we stand just the same chance of doing it that we stand of separating the soprano from a duet.

The logical remedy is to cut down the energy reaching the first tube. The simplest way to do this is usually to cut down the size of the antenna. This is almost always the first thing to try, for the tendency is to make antennas too long anyway. Do not think, as you snip off 25 or 50 feet, and insert an insulator, that you are going to cut down your other reception to the same degree you cut down the feed through. The latter falls much faster, and its disappearance is sudden and definite.

If cutting down the length of the antenna is not practical, a considerable degree of relief may be had by introducing a small fixed condenser between antenna and set. The condenser is not as effective for this purpose as it is against broad tuning, but it helps, and may be sufficient.

The Browning-Drake Two-Tube Kit

Comprising Single Dial Control of One Stage of R. F. and Regenerative Detector

By Glenn H. Browning

The new Browning-Drake kit meets the demand for a neutralized r.f. tuner and detector in one unit, to be used in conjunction with an audio amplifier and *B* supply in another unit which preferably uses a 210 type of power tube. The kit employs single illuminated, drum-dial control, small coils, and a new method of neutralization which permits the use of either storage battery or a.c. filament tubes.

The Browning-Drake circuit consists essentially of one stage of tuned r.f. amplification with a specially constructed slot-wound r.f. transformer, which was developed mathematically by the writer and Dr. F. H. Drake. This is combined with a tickler feedback detector, the stage of r.f. being neutralized. The resulting combination makes a tuner which is both easy to construct and sufficiently selective to enable the operator to receive almost all signals which are above the noise level. The r.f. amplifier has proven to be much more efficient than one stage of neutralized r.f. amplification with tickler feedback on the antenna circuit. This is undoubtedly due to the fact that when tickler feedback is applied to the detector circuit it also causes some feedback in the antenna circuit, thus increasing the amplification of both circuits in the same operation.

The antenna circuit is conductively coupled, the antenna coming in directly to a tap on the antenna coil through a .0001 mfd. condenser. A "trimmer" is used in parallel with the first tuning condenser to make slight adjustments for different stations. The neutralization system, as designed for use with A or a.c. tubes, consists of a number of

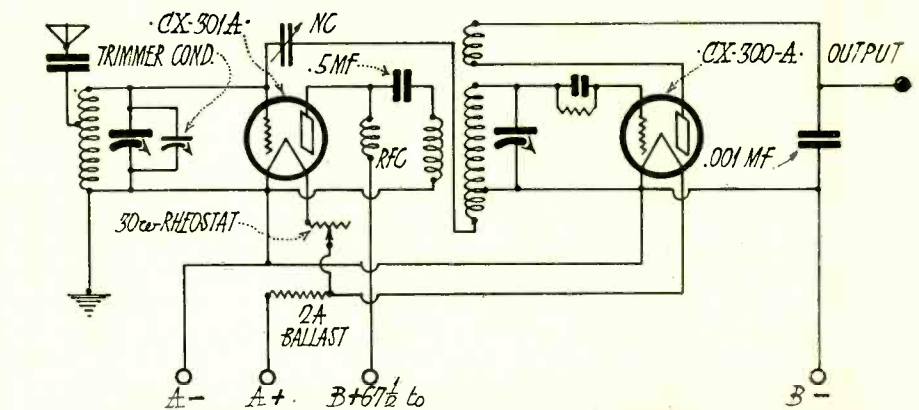

Fig. 1. Circuit Diagram of Tuner With "A" Tubes.

extra turns added on the secondary of the r.f. transformer and the end connected to the rotor plates of the neutralizing condenser, the stator plates then being connected to the grid of the first tube. All r.f. current is kept out of the *B* supply by means of a .5 mfd. condenser in the line which runs to the primary of the r.f. transformer. A parallel feed is employed. This incorporates a r.f. choke connected directly to the plate of the tube, the other end going to the *B* supply.

Shielding is provided for use in receivers close to broadcast stations. This shielding must be kept 1 in. away from the low potential end and 1½ in. from the high potential end of the coils. The coils are consequently wound on 2 in. instead of 3 in. forms.

The tuner kit, consisting of two Browning-Drake condensers driven by a single illuminated drum dial, together with the two coils, is supplied as a single mount unit. In connection with a foundation unit, consisting of front and base

panels with mounting hardware, it may be used as a tuner with any type of audio system. Holes drilled in the foundation kit will accommodate Benjamin four-prong or five-prong sockets.

Fig. 1 gives the circuit diagram for storage battery operation with a 301-A tube as r.f. amplifier and 300-A tube as detector. All filament circuit wiring is under the metal subpanel, rubber bushings being provided to prevent short circuits. Two 299 tubes in series may also be used in this circuit. Neutralization is accomplished by the same method as used in previous Browning-Drake kits.

Fig. 2 gives the circuit diagram for transformer operation with two C-327 tubes. All filament connections are made with twisted pair run under the subpanel. Neutralization is accomplished by setting the condensers at about 15 or 20 on the scale and rotating the tickler coil so that the second circuit oscillates. This may be determined by touching the finger to the stator plates of the

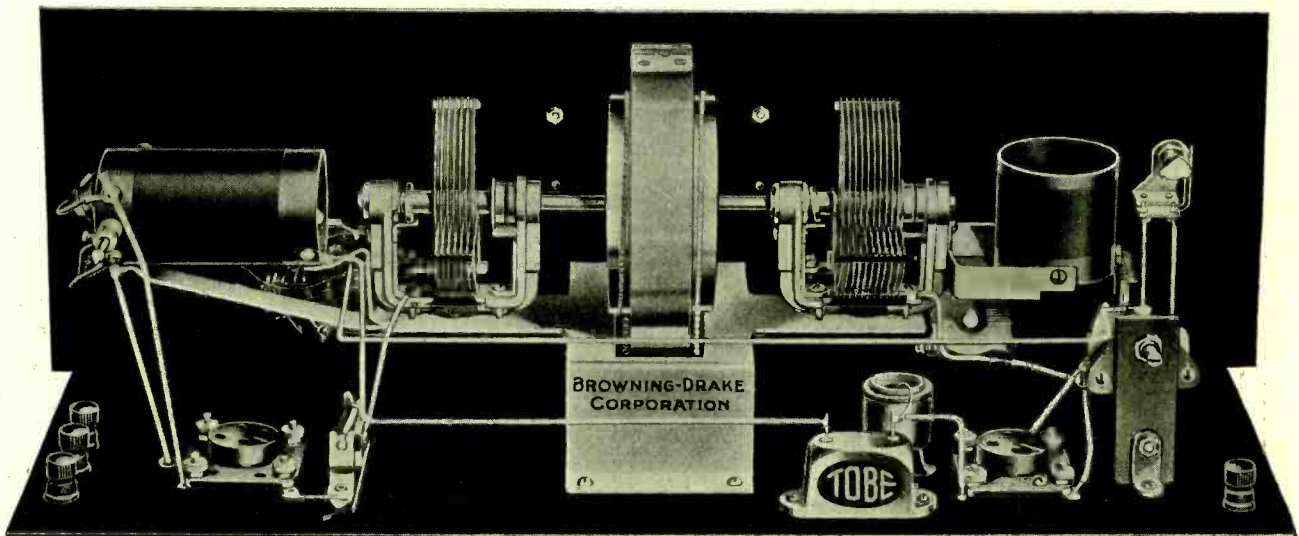

Rear View of Browning-Drake Two-Tube Tuner.

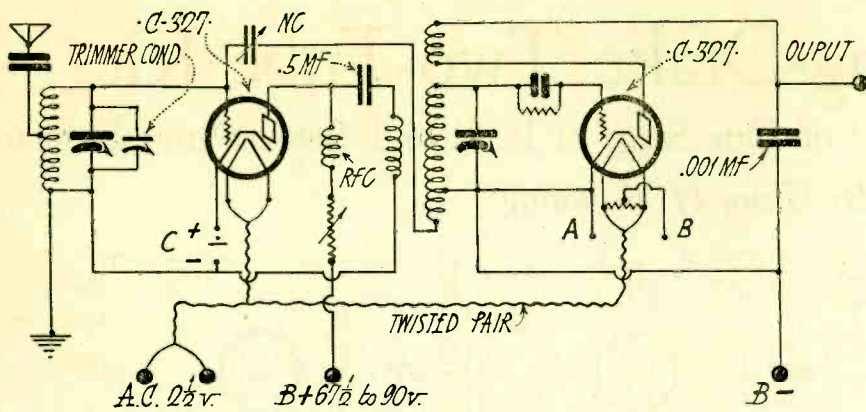

Fig. 2. Circuit Diagram of Tuner With A.C. Tubes.

second tuning condenser (the one to the right as one faces the receiver). Then turn back the tickler so that this circuit goes out of oscillation. Rotate the trimmer condenser. If any setting of the trimmer condenser throws the second circuit into oscillation the set is not properly neutralized and the balancing condenser should be re-set until this test is satisfactory.

The writer believes that if the home constructor is careful in building the receiver described he will be amply repaid for his effort and expense.

Audio Amplifier

THE audio amplifier unit for the Browning-Drake tuning system consists of a completely self-contained, two-stage, transformer-coupled amplifier using a 301-A in the first stage and a 310 tube in the output stage. The amplifier unit supplies all plate and grid bias voltages to the amplifier itself in addition to furnishing plate current for the receiver proper.

It is imperative that a power tube be used in the output stage if full depth of tone is desired. The 310 tube has a maximum undistorted power output of 1,540 milliwatts, or more than 100 times the output of the standard 301-A type. Bass notes require a great expenditure of energy. When we realize how much more energy is required to reproduce the pedal diapason of the organ than the treble of the violin, we can understand the reason for the glaring absence of bass notes in the receivers of yesterday, and the necessity of power tubes wherever full, rich reproduction is expected.

In order to correct a mistaken opinion which many radio listeners entertain, let us state that volume of sound is not the main objective of power amplification. It is not expected that the listener will operate this amplifier at top volume any more than we expect the owner of an 80 mile an hour automobile to travel at top speed through traffic. This amplifier has a liberal fund of reserve power so that it may operate smoothly and reproduce

modulations and crescendos over the entire musical range with a minimum of distortion.

The simplicity of the assembly of the audio amplifier is apparent from first glance at the illustration. This is made possible through the use of the Thordarson power compact R-210. This contains the foundation essentials of the power supply. The rectifier supply of 585 volts, no load, two 7½ volt filament windings for the rectifier and power tubes, and two 30 henry choke coils are all assembled in this unit. As well as reducing the mounting space, this also simplifies the wiring of the power unit, so that a neat, efficient, and compact unit is the result.

The Tobe Deutschmann condenser block R-210 is especially designed for use with the power compact, and contains all the filter and by-pass condensers required in this amplifier. Two common terminals are provided; the one marked C— is common to the three filter condensers; terminal marked B— is common to the bypass condensers. An examination of the diagram will show that the grid bias resistor for the first audio tube is placed between these two common leads.

The output resistors are the fixed vitreous enameled type, and are likewise designed exclusively for this amplifier. Another important feature of this assembly is the use of the voltage regulator tube CX-374. This tube, connected across the 90 volt B supply serves as a ballast to keep the lower B voltages constant regardless of variations in load or fluctuations of line voltage.

A Yaxley relay is built into the amplifier assembly so that the operation of

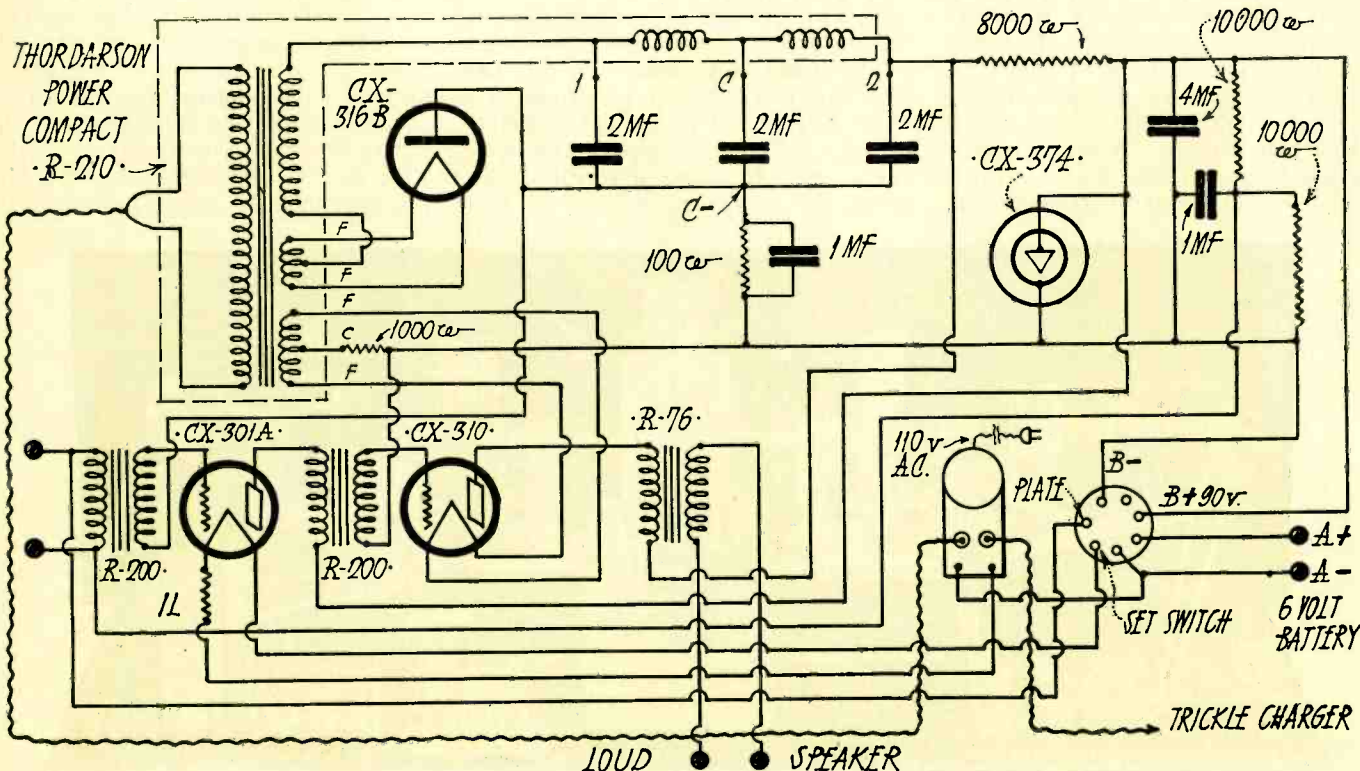

Circuit Diagram of Thordarson Two-Stage Amplifier and Plate Supply Unit.

the receiver will be entirely automatic. The primary of the power compact should be plugged into the socket marked *B* eliminator. Battery and trickle charger connections are clearly marked on the relay. This relay is provided with a shunt consisting of a single strand of resistance wire placed across the battery terminals. As the *A* current drain of the complete receiver and amplifier is exceedingly light, it is necessary that this shunt be removed so that all the current will flow through the relay. If this shunt is not removed, the relay will not function properly with this receiver.

The cable-plug contains all the connections between the amplifier and the tuning unit. The *A*—, *A*+, *B*— and *B*+ 90 leads are clearly marked. Two extra leads are necessary, one to connect the plate lead of the detector to the first amplifying transformer, and the other to connect the *A*— lead of the first audio tube to the switch on the tuning unit. Every lead of the cable plug has an individual color. The following color code is used: *A*— black, *A*+ red, *B*— yellow, *B* 90 gray, *Plate* green, *Filament Switch* brown.

Even though power amplification be used in a receiver, unless the first audio stage is capable of amplifying over a wide band of audible frequencies, the full effectiveness of the power tube cannot be obtained. The Thordarson R-200

PARTS USED IN AUDIO ASSEMBLY

- 2—Thordarson audio transformers, R-200
- 1—Thordarson speaker coupling transformer, R-76
- 1—Thordarson power compact, R-210
- 1—Tobe Deutschman condenser block, R-210
- 1—Thordarson resistance kit, R-508-3445
- 1—Yaxley 100 ohm resistance
- 1—Yaxley resistance, type 1-L.
- 1—Yaxley cable plug
- 1—Yaxley relay
- 4—Benjamin sockets
- 6—Binding posts
- 4—Tubes, CX-301A, CX-316B, CX-374, CX-310

audio transformers used in this unit have a very high impedance primary and a large core cross section, giving even amplification over the entire range of audible frequencies. This insures the least possible distortion in the input to the power tube, and hence a great realism in the output of the entire receiver.

Under load, the amplifier supplies the following voltages:

Plate voltage to UX 210 power tube,	375 volts
Plate voltage to detector tube.....	44 volts
Plate voltage to 1st audio and r.f. tube,	89 volts
Grid bias to power tube.....	25 volts
Grid bias to 1st audio tube.....	5 volts

Two blank input binding posts are provided. When the amplifier is used with the tuning circuit these should be disregarded. They correspond to the input terminals of the first audio transformer and should be used when coupling the amplifier to an electrical pick-up for phonograph operation.

WHAT NEXT?

By "Oldtimer"

Back in the days when wireless telegraphy first became of practical use, the imperative need for a signal of distress brought about the establishment of the call CQD, meaning "Come quick, Danger!"

That was a good call, but it took too long to transmit and was impractical through interference and static. After many years there came the time when a great international convention attended by the foremost celebrities of radio, changed the old CQD to the modern SOS, which, as we all know, has no literal translation. It was easily read through static and interference, and for over seventeen years has been in practical use, indirectly saving thousands of lives and millions of dollars worth of property. Those inaugurating the call, were men of brains and experience, who above all things, knew what they were doing. They did well and SOS has become a universal signal known throughout the world.

Now, there arises a group of publicity hounds who seek to spoil the proven efficiency of tradition with a lot of hokum that they think is better, but which is positively ridiculous.

Six months ago, came an announcement of the International Aviation Congress in London, that the call letters PAN would be used by aircraft in distress. This combination of letters was derived from the French word "Panne," meaning "crumpled."

(Continued on page 59)

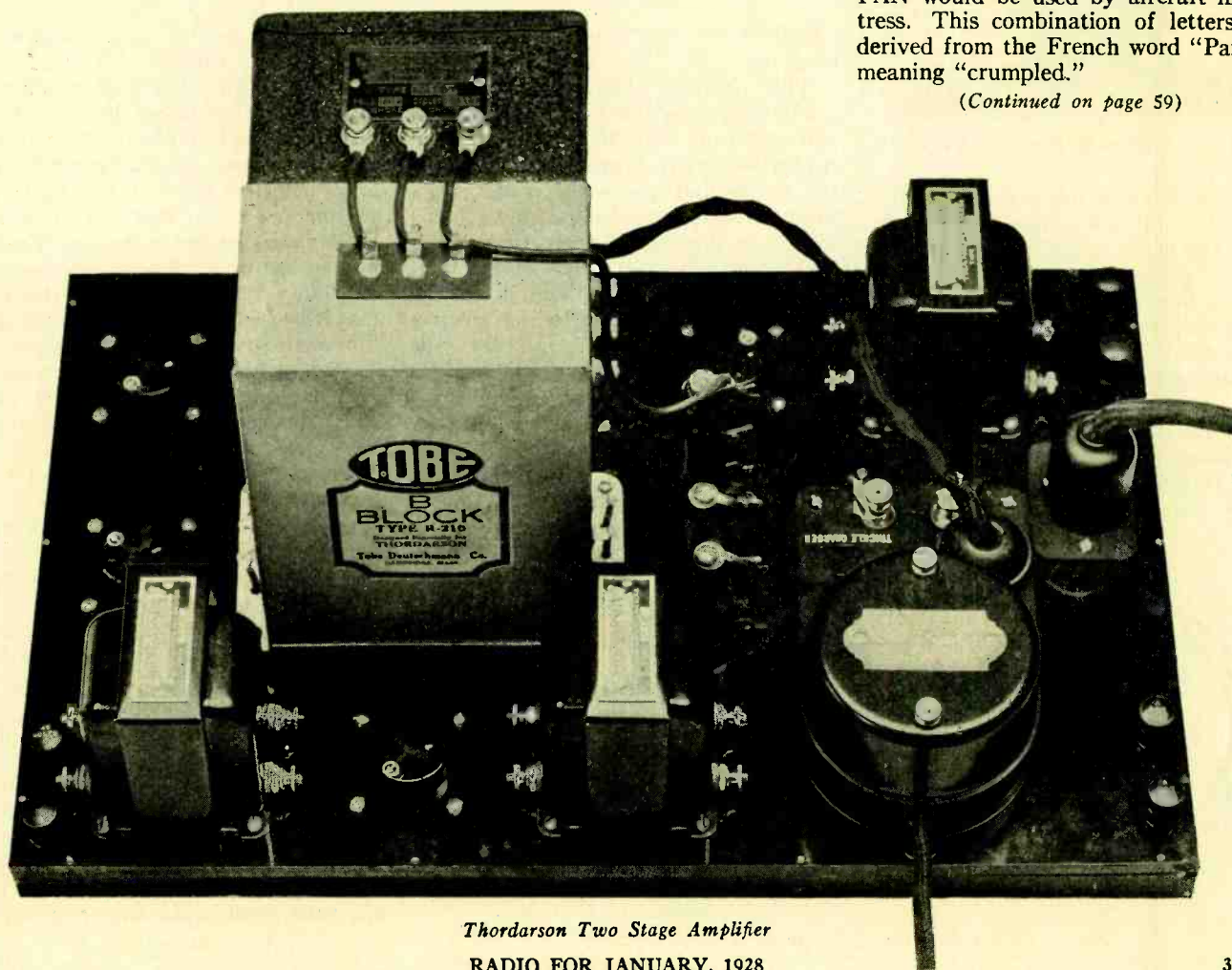

Thordarson Two Stage Amplifier
RADIO FOR JANUARY, 1928

An Automatic Radio Control

By Harry R. Lubcke

WOULD you like to have an automatic radio? One that will perform at your wish without your touching it? Or better, wouldn't you like to make the outfit you now have do this thing, and know that you can accomplish it at very little expense?

Sure you would! Here's how. With practically nothing more than an old alarm clock, a few pieces of wood, brass, and odds and ends, you can accomplish the miracle yourself.

8 to 10 p. m. are to be heard. Contactors of "2 hours length," i. e., subtending an angle of 60 degrees, are placed from the 4 to 6 and from the 8 to 10 marks on the clock face. As the hour hand brush sweeps by these hours the circuit will be closed and consequently the receiver operated. Since, however, the hour hand of a clock makes two revolutions in 24 hours, a cut-out switch actuated by the alarm mechanism is included which permanently opens the

of the component parts we will pass on to their constructional details and then outline the operation of the unit as a whole; which, by the way is very simple.

The wood frame in which the clock is mounted consists of one front piece, two ends, and two columns, detailed in Fig. 3 and shown somewhat modified in the original unit made by the writer. (The corners of the front piece were cut off so it could be swung in a 6-in. lathe.) Any good hardwood is suitable material

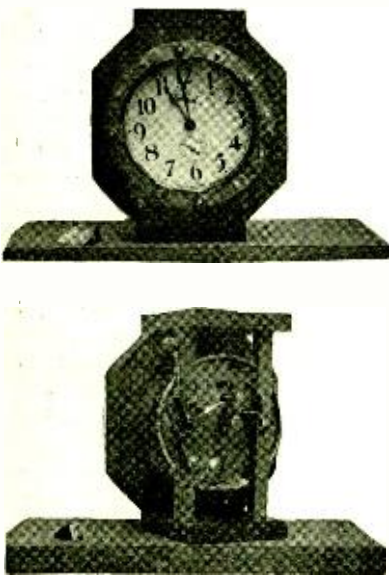

Fig. 1. Automatic Radio Control.

The alarm clock forms the basis of a time switch that closes the filament circuit at any desired time, for any interval of time, opens it, and stands ready for the next interval without attention. It is removed from its case and mounted as shown in Fig. 1, the hour hand being provided with a contact brush that passes over stationary contacts set around the dial periphery.

Stationary contacts are located wherever it is desired to operate the receiver. Assume that programs from 4 to 6 and

circuit at the conclusion of the evening program.

This prevents the operation of the outfit from 4 to 6 in the early morning, and also from 8 to 10 a. m. if desired. A shorting switch is provided that shorts the device and allows the operation of the receiver at any special times, being simply an Electrad filament switch connected across the terminals of the unit. The schematic circuit diagram of the unit and its connection to the positive "A" supply lead, Fig. 2, indicates the function and disposition of the various parts mentioned. If a socket power *B* unit is employed it can be switched off by the simple and common expedient of placing a relay in the *A* battery circuit.

With this explanation of the functions

since there are no radio frequency or high voltages present. The wood parts shown constitute the very minimum required, it often being desirable to embellish the unit by placing it in an ornamental cabinet, especially where there is not sufficient room in the battery compartment, etc., so that it can be made the *invisible* brains of the set. The 4-in. hole in the front piece should be turned out on a lathe since it is imperative that it be truly circular for proper operation of the contact brush. Twelve holes, spaced at the *half hour intervals*, are drilled around the circumference using No. 28 drill and threaded 8-32 for the contact studs. These are laid out to be center punched through the master contact ring so that the holes in it will correspond to the location of the studs. A thirteenth hole is provided for a binding post which forms one of the external connections of the unit.

The columns are bolted to the back of the alarm clock case and thus should be spaced back a distance *A* on the end pieces such that the face of the clock presses tightly against the back of the front piece. This dimension may vary from the one given, depending on the make of clock. Elongated holes are provided in the clock case to allow exact adjustment of the face in the 4 in. hole. Turning now to the metal parts, Fig. 4, the hour hand brush holder is made of

(Continued on page 63)

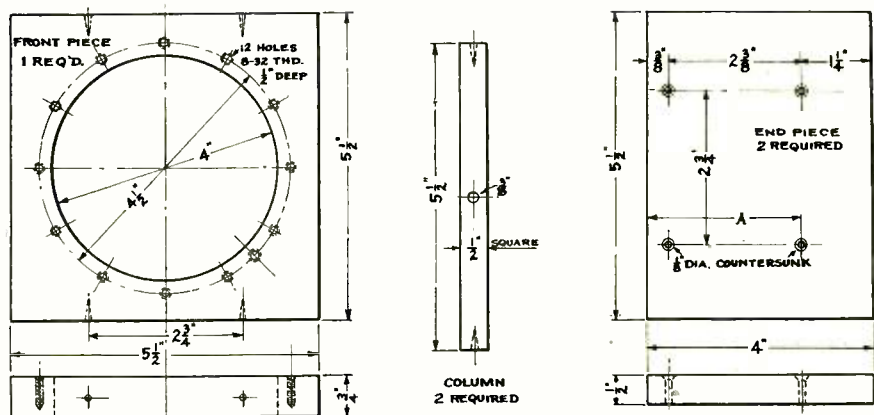

Fig. 3. Details for Wooden Frame.

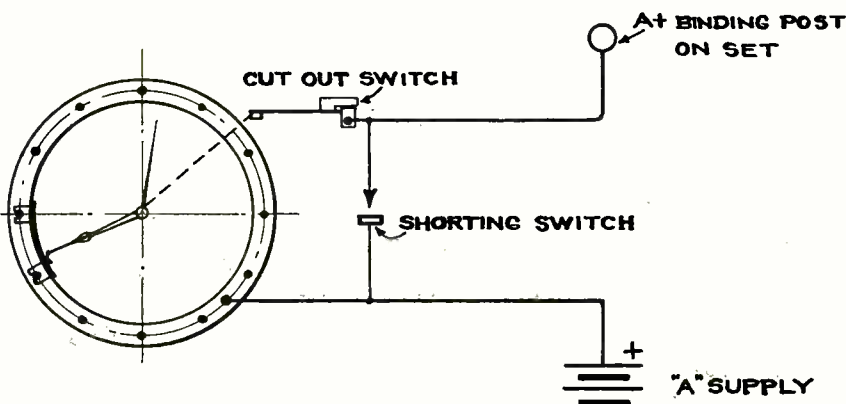

Fig. 2. Circuit Diagram of Automatic Radio Control.

Notes on Radio Prospecting

By J. E. Smith, President National Radio Institute

(Concluded)

Let us now take up a case, that of examination from the interior of a working mine, and from the exterior, to determine the presence of a mineral zone whose existence is suspected. Fig. 3 explains this case, which is that of a zinc mine containing calamine mixed with lead carbonate and hydroxide.

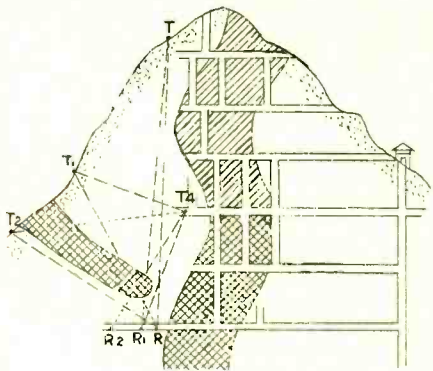

Fig. 3. Examination From Mine Exterior.

To start with, the transmitter is placed at the point T , and the receiver is placed in a drift at the bottom of the mine at the point R ; the clear sound produced in the telephone shows that the line TR is clear of all mineral deposits. Leaving the receiver at the point R , the transmitter is carried down the hill to the point T_1 ; the transmitter is allowed to remain in operation while it is being moved from T to T_1 , and the operator, listening below, finds a rapid diminution of the sound, and as the point T_1 is reached, the telephones become silent. This shows the presence, which we may assume has been suspected by other indications, of a new mineral zone; keeping the receiver at the point R , the transmitter is carried down the hill still further toward T_2 . At a certain moment, the sound which was lost is again heard; it gradually becomes stronger, and finally is heard with full intensity, which indicates that on a given line, RT_2 , the rock again is completely sterile. At this point, the operators trace a profile of the terrain explored, and then apply other tests. The transmitter is carried to the point T_1 at the end of a drift, and the receiver is placed first at R_1 and then at R_2 , then, at T_1 and then, at T_2 . This gives four new lines. T_4R_1 shows the end of the deposit; T_4R_2 controls and confirms the preceding test; T_4T_2 indicates the presence of the deposit higher up; T_1T_4 indicates the sterility of the rock in this direction. Thus, the operators are able to complete the profile, acquiring an approximate section of the mineralized mass as discovered.

The work is continued afterwards on other sections of the deposit, so as to delineate with the greatest possible accuracy, the point of contact with sterile rock surrounding it and its precise boundary. The data thus obtained are controlled and completed by experiments using the other systems. A confirmatory test which would be quite interesting, is that obtained by stretching a long wire on the left side of the hill, as shown in the drawing, making good earth contacts on two out-crops, measuring the resistance of the intervening soil, and then taking one of the earth contacts out of the out-crop and carrying it away to a certain distance between T and T_2 . In the first case, the circuit is closed through the two deposits, and the small zone of sterile ground between the first two points indicates the presence of ore by having only a slight resistance, while in the second case, the circuit is closed through sterile ground only, and the resistance increases. This shows that the distance between the nearest point of the two deposits is less than the distance from the out-crop to the point in which the second earth contact was made. These data are useful when taken in connection with the Hertzian test.

Fig. 4 shows a third case of application of the Hertzian method; two shafts were excavated below a mass of manganese ore, and reached the point where

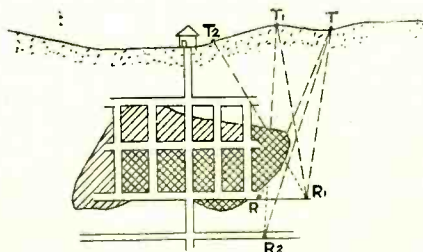

Fig. 4. Examination From Mine Interior.

the mass thinned out and disappeared. The question then was to know whether there was a break in the deposit, or whether this was a definite end of the deposit, so as not to keep on pushing drifts without finding any more mineral.

The first investigation was carried on in the open with direct observation, and the result was negative over a large piece of territory to the right of the excavation. It was feared that owing to the depth of the new body searched for, and the low power of the transmitter used, the results of the examination would not be positive, and it was decided to try the Hertzian method. The receiver was

placed at R_2 at the extreme end of the lowest drift, and the transmitter was placed at T_2 , near the entrance of the excavation. The operator placed at R_2 could determine exactly the lay of the deposit. He then gave orders to the operator in charge of the transmitter to carry it to T_1 , and found that on the new line there was no mineral mass.

The test was repeated, placing the transmitter at T , and with the same results when the transmitter was placed at R_2 , and the discharge tested towards R . The operator then took the transmitter into the shaft below to its extreme end and found that emissions from T were received, while those from T_2 were not. The experiments were then repeated, taking the transmitter a good distance to the right of T , and changing positions in the direction normal to the line T_2 , T_1 and T . It was found that the propa-

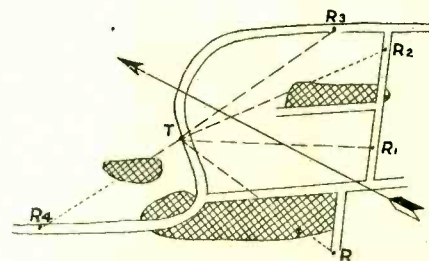

Fig. 5. Determination of Ore Body.

gation of the waves was not interfered with and that, therefore, there was no trace of mineral in the subterranean section explored.

In Fig. 5 is shown a test directed to discover a mass of ore, the probability of whose existence followed from the vicinity of other metal-bearing deposits in an active mine whose plan is shown. The Hertzian transmitter was placed at T , and the first experiment consisted of placing the receiver at R_2 , in order to be sure that the quality of the mineral of the known deposit was such as to make a screen along the way. Having determined this, the operator at R_2 moved along slowly, following the drift towards R_3 , at which position, he began to catch the waves and thus established the line of contact of the bed being explored. Continuing to go on toward T , the operator employed a positive knowledge that all the region between the drift and the deposit was sterile.

The operator then went to R_1 and followed along the drift between the same deposit, which was without mineral. Finally, the operator covered the whole gallery, which was dug in sterile ground in the direction of R_4 , and having thus gotten to its end, found the

sound had ceased, which proved that there was a new deposit in the line explored.

The apparatus used in the Hertzian system consists of a transmitter and a receiver. The transmitter 320 volts may be had from a small dynamo on a

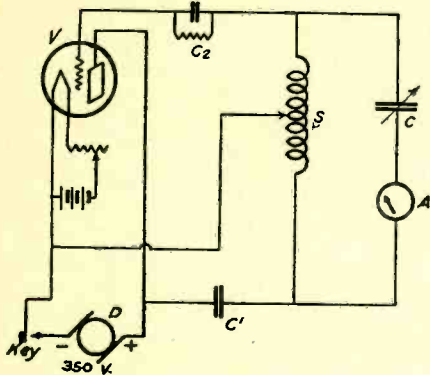

Fig. 6. Circuit Diagram of Transmitter.

wheeled platform or a battery. Three vacuum tubes are used in parallel. Fig. 6 shows this transmitter to be the usual Hartley type. This apparatus has no aerial or ground connection, giving it great mobility and making the exploration easy. The radiating system consists of an inductance about 8 in. in diameter, wound around the box containing the vacuum tubes, which is mounted on a tripod so as to be turned about as desired. The radiation of the waves can be produced in any desired direction. The whole transmitting set may be mounted on a small truck so as to make it easily transported either on the surface or in the drift.

The circuit diagram of the receiving apparatus is shown in Fig. 7. In this,

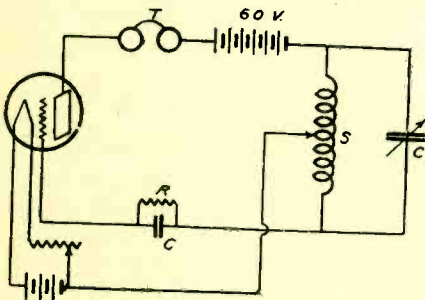

Fig. 7. Circuit Diagram of Receiver.

too, the inductance is wound around the box, which last is carried by the operator, or placed on a tripod, while the plate and filament batteries are held by the assistant.

This system is far in advance of the first attempts, using a magnetic means, and those of Schlumberger with polarized electrodes. The main drawback of all of the previous systems, is that each requires too long a time to make the test and determine the nature of the earth surveyed.

The rapid development of radio apparatus, such as the vacuum tube, has led to the disclosure of a comparatively new phenomenon known as "re-radia-



Radio Prospecting Instrument.

tion." Applied to the art of mining this gives every assurance of opening up vast territories of mineralized ground, especially in areas hitherto not amenable to prospectors.

Re-radiation may be described as the occurrence of a secondary electromagnetic field about a conductor, which is located within a primary electromagnetic field of high frequency. These secondary fields may be caused to reach out into space, to comparatively great distances, from the secondary conductor about which they exist. Recognition of this phenomenon, together with an understanding of the many factors which control it, have enabled some engineers to develop a means of locating unknown conductive bodies and more particularly, ore bodies which are electro-conductive.

While a complete understanding of the principles involved in the application of re-radiation to the location of unknown conductors, requires a thorough understanding of high frequency electrical phenomena, the basic principles are easily grasped by those having only an elementary understanding of electricity and radio principles. These elementary principles will be outlined in the following paragraphs in a broad and easy manner so that they may be readily understood.

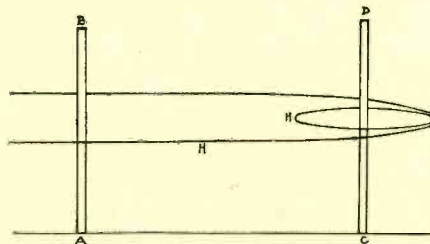

Fig. 8. Principle of Re-Radiation.

Referring to Fig. 8, there is represented in profile view, a vertical conductor *AB*, and a vertical conductor *CD*. The reader must imagine that alternat-

ing current of high frequency is flowing in the conductor *AB*, which will be called for convenience's sake, the primary conductor, and that as a consequence, there exists about this primary conductor, a high frequency electromagnetic field, called a primary field, the magnetic lines of force of which may be represented as circular lines similar to the lines *H*, spreading out and contracting about the primary conductor *AB*, as an axis. The lines of magnetic force *H* have the ability to travel through space even if this space be filled with non-conductive material, and they further have the ability to cause an electric current to flow in any conductive material through which they might travel. It may be easily imagined then, that when the lines of magnetic force *H*, cross the conductor *CD*, they will cause a current to flow therein. This current is called a secondary current, and it will

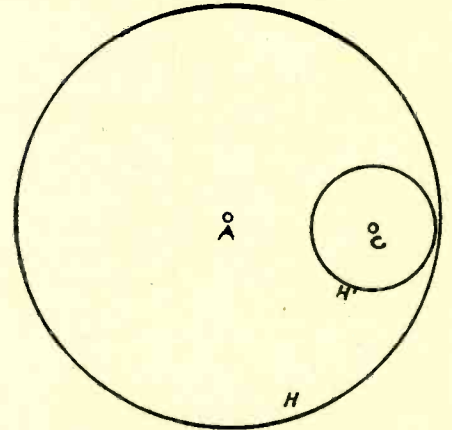

Fig. 9. Plan View of Re-Radiation.

of course, be accompanied by its own electromagnetic field. This latter electromagnetic field is called a secondary field, represented by the circular line *H₁* of Fig. 8. In Fig. 9, there is shown, drawn to a smaller scale, a plan view of the conditions pictured in Fig. 8.

Now all of the above phenomena are well known to those versed in the art of high frequency electricity, but it has been generally thought that unless the secondary conductor *CD* was very close to the primary conductor *AB*, and unless the secondary conductor be tuned to the frequency of the current flowing in the primary conductor, just as a radio set is tuned to the frequency of the broadcast station which one desires to hear, the secondary current flowing in *CD* and its accompanying secondary field would be infinitesimal, so very much so, that it would be useless to attempt to apply this phenomenon to any practical purpose.

It has been found by those responsible for the development of this process that, contrary to expectations, the secondary field about the conductor *CD*, can be made of sufficient intensity to actuate indicating devices at considerable distances away from the conductor, even

(Continued on page 60)

How to Build the Lynch National 5

A Modern Receiver for the Home Constructor,
Simple to Build and Reasonable in Price

By A. Henry

CIRCUITS may come and circuits may go but the simple arrangement of a stage of tuned radio frequency with a combination of regenerative detector and resistance coupled audio amplifier, still remains hard to beat.

In an attempt to meet the requirements of the present day home constructor, Arthur H. Lynch has recently spent much time both in his experimental laboratory at Garden City, Long Island, and in consultation with a number of leading engineers in the radio industry in order to evolve a method that would materially simplify the process and reduce the cost of home constructing a high grade radio receiver.

The result is the device shown in the pictures and known as a "deck." The "deck" is a compact sub-panel of Westinghouse micarta with everything necessary for making a five tube receiver—except the tuning units—mounted right on it. In other words, it contains the complete audio system with additional sockets for the detector and radio frequency amplifier tubes.

The audio amplifier, which is of the three stage resistance coupled type using metalized filament resistors, is so arranged that most of the connections are automatically made by the riveting of many of the socket contacts directly to the resistor clips to which they would otherwise have to be connected. Likewise, the coupling condensers are made in tubular form like the resistors, and clip into the special mountings made for them by the same clips that hold the resistors.

A rather novel arrangement is provided in the detector grid circuit. Here again, a double mounting is provided

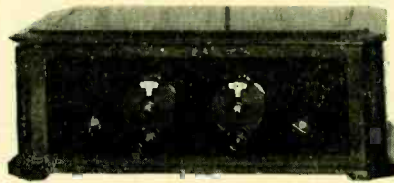

The Lynch-National Five.

for holding both the grid leak and the cartridge grid condenser.

Along the back edge of the "deck" are provided a series of holes for binding posts. The posts are not, however, supplied with the "deck" as many constructors may prefer the use of a battery cable

One more feature worthy of mention in connection with the "deck" is the space provided for the mounting of fixed filament control resistors, neutralizing

ing illustrations, the new National "two-inch" antenna tuning unit and tuned radio-frequency transformer with the well known and highly efficient slot wound primary are employed.

The circuit employed is that standard to which old designers tend to revert when they want a sure-fire receiver capable of real satisfactory results—a stage of tuned radio frequency amplification and regenerative detector with the added selectivity and sensitivity to be had by the use of low loss condensers and highly efficient tuning inductances.

The first of the few simple steps to be taken in the construction of the set is to prepare the panel, as shown in Fig. 1. The next, is to mount the additional clips for the grid suppressor and the filament equalizer, the binding posts, the antenna series condenser and the two

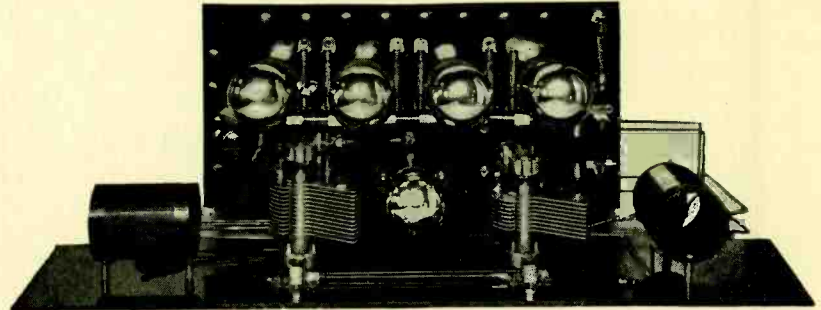

Top View of Lynch-National Five.

condensers, phasatrols, grid suppressors or any other similar devices.

Aside from the "deck" and a suitable front panel, the only other major parts required for a complete receiver capable of excellent all 'round performance in general, and tone quality in particular is a pair of tuning units.

As will be seen from the accompany-

variable tuning condensers on the "deck." The "deck" may then be partially wired before mounting on the panel along with the tuning inductance and dials.

One of the most important of recent developments in the progress of the radio art has been the placing on the market of "special purpose" tubes. In

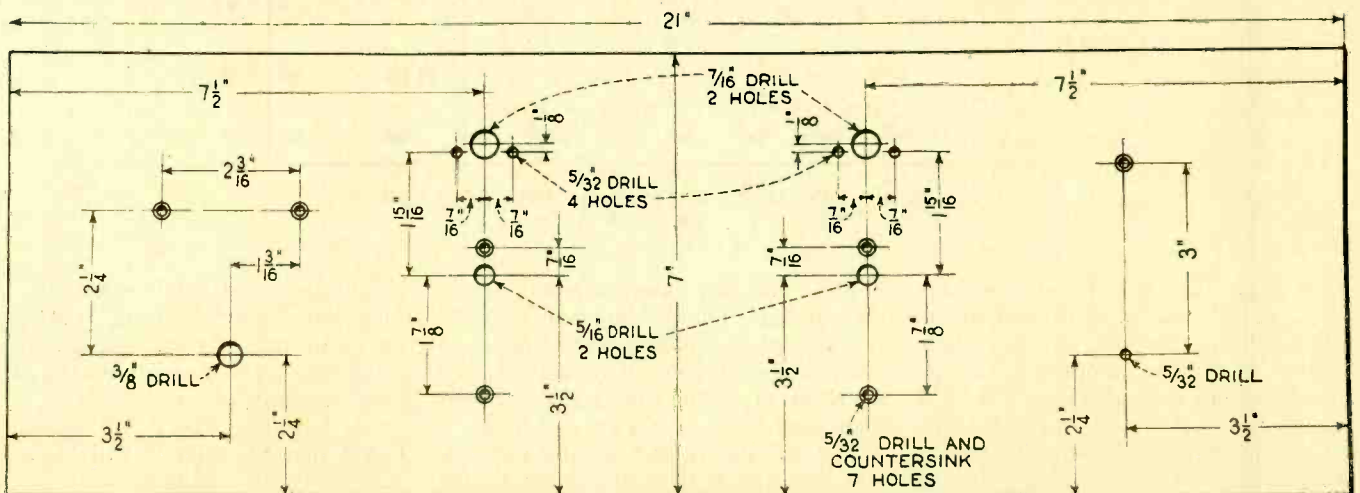
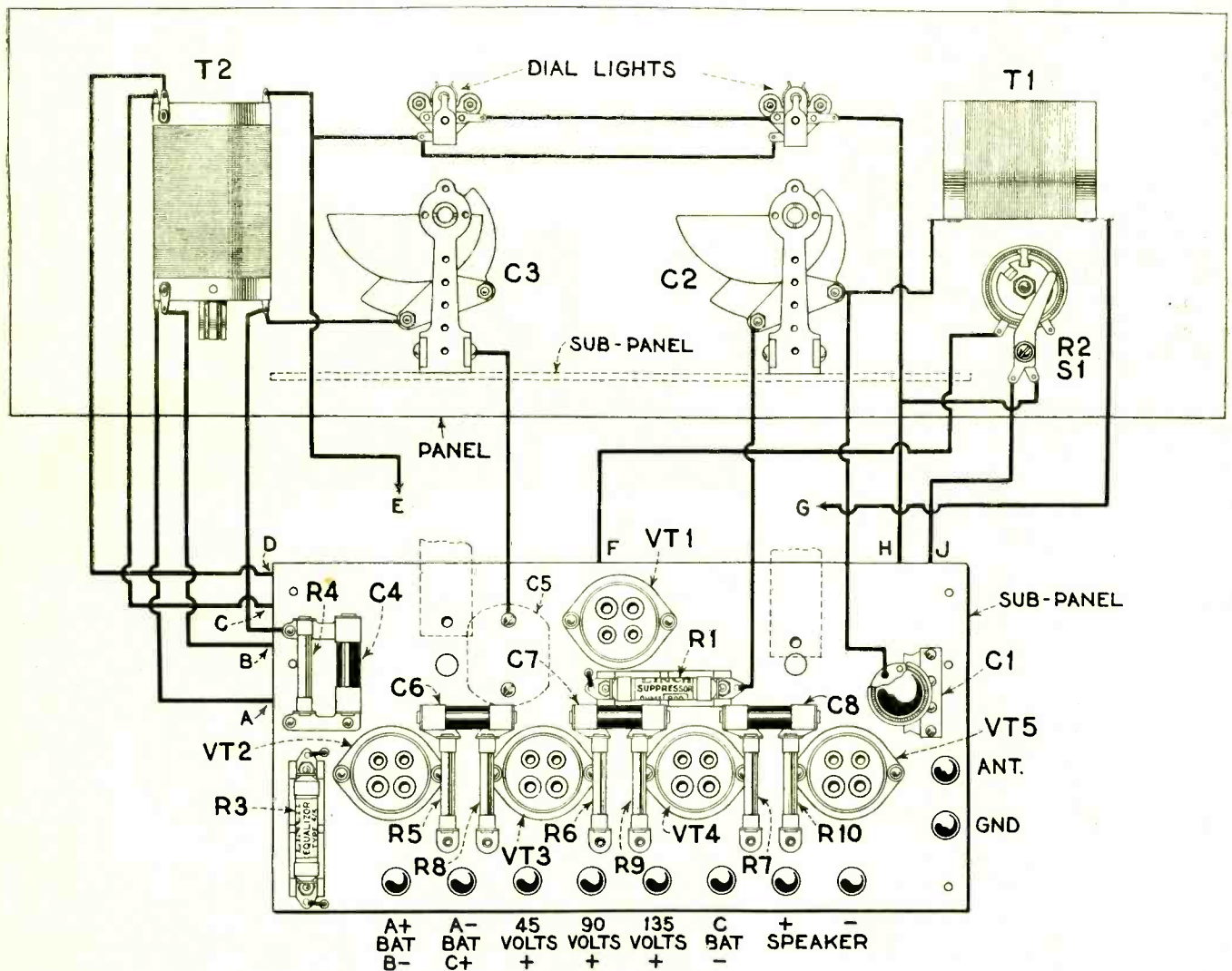
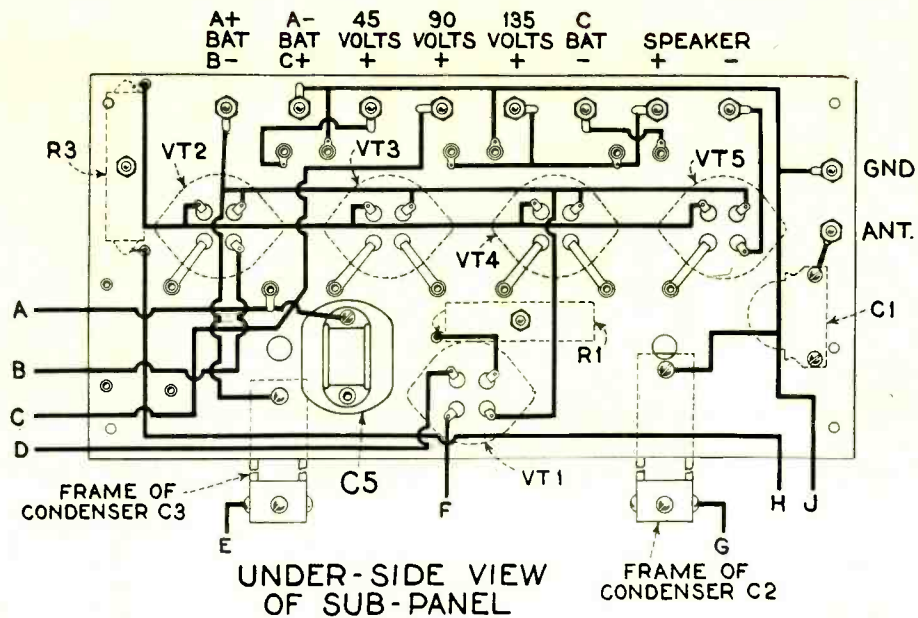

Fig. 1. Panel Layout.



former times the one type of tube—the 201 or 201A—was used throughout as radio amplifier, detector, audio voltage amplifier and power amplifier. Like the proverbial “Jack-of-all-trades,” it was master of none. Gradually during the past year, however, radio frequency tubes, special detectors, high mu or voltage amplifiers and that essential for

good quality, the power tube have made their debut. The development of these tubes is unquestionably one of the most outstanding advances that has yet been made in providing the general public with good radio broadcast reception.

The r.f. tubes, such as the CeCo K and the special detectors, such as the CeCo H, mean greatly increased sensi-

tivity and more stable operation. The high mus provide greater volume, and the power tubes, perhaps more than anything else, are responsible for the present high standards of tone quality.

For local reception it will generally be found that exceedingly satisfactory results may be obtained with a short

(Continued on page 49)



QUERIES and REPLIES

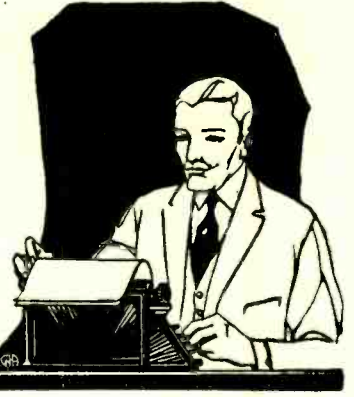

Questions of general interest are published in this department. Questions should be brief, typewritten, or in ink, written on one side of the paper, and should state whether the answer is to be published or personally acknowledged. Where personal answer is desired, a fee of 25c per question, including diagrams, should be sent. If questions require special work, or diagrams, particularly those of factory-built receivers, an extra charge will be made, and correspondents will be notified of the amount of this charge before answer is made.

I plan to construct a low powered testing outfit for matching or neutralizing receiving sets, and would like a circuit diagram of a three tube tester, consisting of an audio oscillator, r. f. oscillator and modulator tube, with appropriate controls so that the output of the modulator can be regulated.—G. H. G., New London, Conn.

The circuit you wish is shown in Fig. 1. It consists of a vacuum tube audio

range from 40 to 1500 meters. What type of condenser will have to be used for regeneration in the antenna circuit?—F. W. K., Cleveland, O.

Fig. 2 shows a good arrangement to cover all wave bands. For wavelengths above 600 meters, you may either wind special coils, or tune the 200-550 meter coils with condensers of larger capacity. As the latter is easiest, the diagram shows two fixed condensers which may

have a rather high effective resistance. On the very short waves, you will probably not be able to do very much with the regeneration condenser, as it will be critical in adjustment, and body capacity will be bothersome unless the condenser has an extension shaft of hard rubber. If c. w. telegraph signals are to be received, a separate beating oscillator must be used, and adjusted to a frequency nearly that of the intermediate amplifier, so that an audible beat note can be heard.

Would like to know what changes should be made in a Silver Marshall type 110-A coil so that it can be used as an oscillator coupler in the Best 45 kilocycle superheterodyne?—E. F. E., Dallas, Texas.

Assuming that the tuning condenser has both rotor and stator insulated from the dial shaft, there are no changes required to adapt the coil to the circuit. Connect terminal 1 to the loop, terminal 2 to the grid of the 1st detector, 3 to the minus $1\frac{1}{2}$ volt C battery, 4 to the grid of the oscillator tube, 5 to the plate and 6 to the positive 45 volt B battery, with the tuning condenser connected between terminals 4 and 5.

Have a 1924 model Best super, and am troubled with harmonics from some of the nearby stations, which I would like to eliminate if possible. Kindly publish the needed instructions.—H. S. V. G., Columbus, O.

It is not practicable to change the intermediate frequency peak of your receiver in order to eliminate trouble from harmonics, so that the best method is to improve the selectivity of the front end by adding a separate stage of tuned r.f. amplification ahead of the 1st detector. In this way, the selectivity is improved sufficiently to avoid harmonic trouble without changing the design of the set itself.

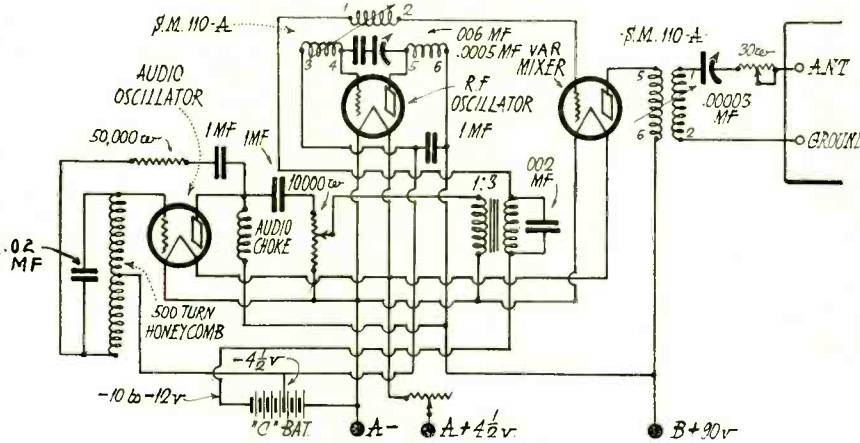

Fig. 1. Circuit for Testing Radio Receivers.

oscillator, which is adjusted to about 1000 cycles, so as to produce a tone which is pleasing to the ear; a high frequency oscillator which can be tuned through the broadcast range, and a mixer or modulator tube, the output of which is connected to a dummy antenna, and in turn to the input of the receiving set which is to be tested. All three tubes are type 99's, with 90 volts plate. The mixer tube has the C battery so adjusted that the plate current is practically zero when the r. f. oscillator is not operating, or the audio oscillator output is at zero. By adjusting the coupling of the rotor in the r. f. oscillator and mixer output circuits, as well as the amount of audio frequency energy being fed into the mixer, the right degree of modulation can be obtained, as well as the correct output into the dummy antenna. The latter is adjusted so as to imitate an average outdoor antenna, so that the values shown in the diagram are approximate. It is best to mount all apparatus in a shielded box, and to ground the shields, as the r. f. oscillator might feed directly into the wiring of the set if it is of the non-shielded type.

Kindly publish a circuit diagram for the antenna and oscillator coupler arrangement for a superheterodyne, using Silver-Marshall plug-in coils, and Remler .0005 condensers to cover the wavelength

be shunted across the antenna secondary condenser, and the same for the oscillator condenser. Blank coil forms may be obtained, for winding the longer wavelength coils, but as they are slotted for space winding, it will be rather difficult to place bank winding on the forms, or to use smaller wire and more turns, as in the latter case the coils would present a very poor appearance when finished, and due to the small sized wire, would

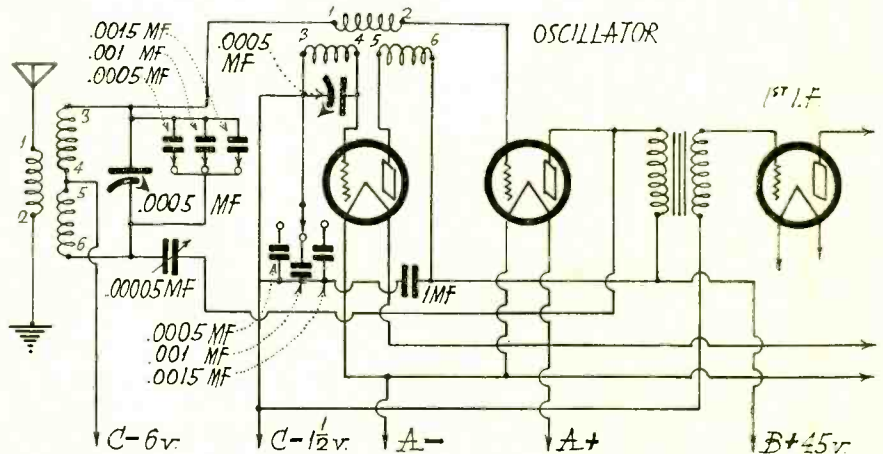

Fig. 2. Oscillator Circuit of Superheterodyne for 40 to 1500 Meters.



The COMMERCIAL BRASSPOUNDER

A Department for the Operator at Sea and Ashore



Edited by P. S. LUCAS

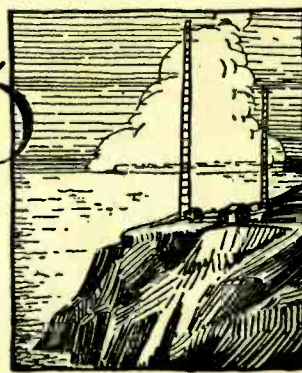

QRX? SURE

No editorials this month. With such material as Mickey Doran's and L. B. Smith's and Bob Koch's more than filling the allotted space, the Department Editor is going to take a back seat and enjoy himself.

Before signing off, here is that star box we promised to start. Anyone desiring to see a story about any ship or station or interested in knowing something about commercial radio in any certain locality is invited to write in and ask for it. We'll print the request in this box and hope that someone who can will shoot us the dope.

* * * * *

* **WANTED: INFORMATION** *

* What is the operating game like on the *
* Mississippi River? *
* *
* What coastal stations are located along *
* the southern coasts of South America? *
* Give LL to U. S. *
* * * * *

KII—KIIA—KIIB—THE S. S. MALOLO (FLYING FISH)

By R. O. Koch

Pretty snappy Great Lakes correspondent, to climb down out of WMW and pilot his gas buggy all the way to Los Angeles in order to write up a ship for us. Well, that's what happened, and here's the story to prove it.

Since the time that Lucas wrote a little article about the construction of the S.S. *Malolo* in 1925, it has been my ambition to see this super-ship when completed. The fruition of my dream was realized on November 10th when the huge liner docked at Terminal Island, Los Angeles, on her maiden voyage. Lacking lucidity of expression, I hope to give you some idea of what the *Malolo* is like—especially her radio installation.

I had better start by saying that I started from Los Angeles in my 4 k.w. M.O.P.A. Chevy, armed with a note book, camera and copy of RADIO. A camera always adds to the aspect of a reporter, although in my case, it usually makes little difference whether it is loaded or not—the results are the same.

Enroute to Terminal Island, I stopped at KSE to find out where the *Malolo* was docked. The boys were too busy to go along, much to their dismay. I guess they were still working on the deluge of traffic sent to them the night before by KII.

Driving on to Terminal Island, I could see the high masts, the beautiful cage aeri-als, the numerous flags and banners, and the blue tips of the *Malolo's* two huge funnels. All roads led to berth 232A that day. 5000 people waited to go aboard. The gates were opened at 2 p. m. I was tempted to play fire chief in order to solve the parking problem, but the Wisconsin license was a bit too conspicuous. Those nice open spaces were hard to pass up!

When the gates finally opened, I made a bee line for the radio room which is located forward on deck A. Perhaps I should describe the aeri-als first, as I saw them before anything else. The main aerial is a six wire T cage suspended between the masts. It has two of the big brown RCA glazed porcelain insulators in series at each end. Another six wire cage is suspended between two brackets which are fastened on the starboard side of the stacks chiefly for receiving purposes. There are also two single wire aeri-als which are somewhat longer than the small cage. All of them are insulated with porcelain insulators.

My eyes got a treat when I entered the cabin on the starboard side. The radio room is easily accessible to passengers, and has a beautiful glass front through which they may see for themselves whether it is radio or wireless. One look through the glass, and I knew that I simply HAD to get in there. It was fortunate that operator Carroll responded to my knock at the door! All the ops were present, but Mr. Watson, the chief, was engaged in his beauty nap so was not visible, though audible at about sixty cycles.

Operators Clark and Carroll were most hospitable when they learned of my mission, and answered my numerous questions in every detail. Incidentally, we have three more ops that read "The Commercial Brasspounder" now, and I hope that they will offer some stories of their experiences at some future date.

My impression when entering the operating room was very similar to the one I had the first time I entered the room on old WFW—my first job. These two radio rooms represent both extremes, but my impression was quite the same.

Along the front of the room is a beautiful full-length table. On it are two IP 501-A receivers with two steps of AF amplification, two keys, a mill, a new type GE switch, and necessary stationery, etc. The keys are the new RCA "back contact" type. That is, there are two sets of contacts working oppositely. A Leach break-in relay is used. The new GE switch is a novel device. With it, the op has his choice of using either transmitter with either receiver, and either break-in system, or antenna switch. Both transmitters and receivers can be used simultaneously.

About five feet in back of the operating table, and parallel to it, are the two transmitter panels. The big one is a GE type T2, and the small one an RCA 3628.

A few words about the transmitters may not be out of place. The T2 takes 8½ k.w. from the ship's line!!! Yes, the *Malolo* is an American ship. Hw? The circuit is a M.O. P. A. with one 211 tube as a M.O. and four 211's as intermediate frequency amplifiers, with the two big 1 k.w. bottles as main power amplifiers. The workmanship is beautiful throughout. The wavelength range is from 550 to 2800 meters. Keying is accomplished by blocking the tubes with a high negative grid bias when the key is up. This particular transmitter has a few improvements incorporated in it which will not be found in any

of the older sets. A look at this T2 will serve to remind anyone that not quite ALL the improvements are confined to B.C. sets.

The 3628 uses eight 211's, and has practically the same wavelength range as its big brother. Both sets have CW and ICW. I was rather surprised to find that the ICW is the chopper variety. The big set was used rarely on the maiden voyage, as the smaller one performed unusually well. WSC was worked nightly up to the time that the ship docked at Terminal Island. The ops had a sked, and were going to try to keep QSO all the way to Honolulu. They also worked the Leviathan shortly after leaving New York. WSN was nearing Southampton at the time. The big set was used for this QSO. KPH was worked consistently all the way 'round. Indications are that some records will be shattered when KII has a little more time to show what she can really do. The ops work shifts of four hours on and eight hours off.

Lifeboats Nos. 1 and 2 are equipped with ¼ k.w. Wireless Specialty impact transmitters. They are licensed under the calls of KIIA and KIIB. A gas engine generator supplies power.

Emergency power for the 3628 is furnished by a bank of Exide batteries. The T2 cannot be used except when the ships' generators are running on account of the enormous load.

An RCA direction-finder, and a Radiola 28 Superhet BCL receiver completes the radio layout. It is about the most elaborate and beautiful shipboard installation one could imagine. The complete absence of both arc and spark may make it seem a bit incomplete to some. However, operators are slowly getting educated to tube transmitters, and at this time their stability is pretty well established. So much for the radio installation.

The *Malolo* is said to be the most luxurious and largest ship to be built in America. She was built by the William Cramp and Sons Ship and Engine Company of Philadelphia at a cost of six million dollars. She is driven by two sets of turbines which are capable of driving her through the water at a speed of 26 knots per hour. No wonder the ops want speedy service on their traffic! She makes the trip from San Francisco to Honolulu in four days—one day quicker than other ships on the same run. Oil is used for fuel.

The huge vessel has accommodations for 650 first class passengers. All rooms are outside rooms, and each has hot and cold running water, both salt and fresh. She is 582 ft. in length, with an 83 ft. beam, and a loaded draught of 28.6 ft. She carries a crew of 336. The seven decks of the liner are served by three elevators. The dining salon will accommodate the entire passenger list at one sitting.

A huge Pompeian swimming pool, two motion picture theaters, a wonderful ballroom, a gymnasium, a children's play room, and a telephone within reach of every bed, are the most outstanding of her many unusual features. The ops are T. M. Watson, J. S. Clark and H. C. Carroll. All were formerly east coast men. They seem to be very well pleased with their new "home." Who wouldn't?

N.E. PACIFIC WEATHER REPORTS

By L. O. Doran

The major weather bulletins, in code and plain language, sent twice daily by NPG San Francisco, cover the entire Coast above San Diego. The ship reports, sent as a part of these bulletins, give the position and weather of every reporting vessel in the northeast Pacific.

Local weather reports as transmitted by Naval stations and lightships are given in a separate schedule list.

Ship operators unfamiliar with lightship schedules, or just plain careless, usually manage to interfere with these broadcast so that the air is jammed with requests for repeats for some time after each schedule.

KPH sends the plain language portion of NPG bulletins and also the observations from WWBV, S. F. lightship.

The only weather bulletin covering the run south of San Diego to the Canal is sent by XDA, Mexico City, after the time signals. Code observations and plain language (Spanish) forecasts are transmitted.

The Mexican west coast spark stations repeat the plain language portion of XDA bulletins immediately after XDA finishes, about 11:30 a. m., P.S.T. (2:30 p. m., E.S.T.) Some of these stations use English. XAF, XAK and XAN are on 600 meters and XAE is near 800 meters. All of these stations are spark with a very broad wave and they call QST 40 times or more before starting the weather report so that there is little excuse for not hearing them.

Most ship operators in this region are coming up from chow about this time and go on the air with a bang, sending TRs for relay north. This interference generally makes hash of the Mexican stations' reports and the unfortunate operators who failed to copy XDA, keep the air hot with QRTs and other cuss words in a generally vain attempt to stop the QRM.

Moral—copy XDA.

In NPG major weather bulletins, key letters are sent indicating various observation stations, followed by two or more code groups of 5 figures each. Only the key letters and the portion of the code of interest to vessels are given here. See Hydrographic Office publication H. O. No. 205, page 121 and supplements:

Key letters: TAT, Tatoosh Island; SE, Seattle; NH, North Head; PD, Portland; EUR, Eureka; SF, San Francisco; PAR Point Arguello; SPE, San Pedro; LA, Los Angeles; DL, San Diego.

First code group: First three figures indicate barometer reading in inches with initial figure omitted; thus: 990 indicates 29.90 inches or 004 indicates 30.04 inches, etc. Fourth figure wind direction as in following code:

Wind direction: 0—Calm, 1—N, 2—NE, 3—E, 4—SE, 5—S, 6—SW, 7—W, 8—NW.

Fifth figure is wind force in Beaufort scale, 0 to 9. The letters W, S and H are sent for wind forces of 10, 11 and 12.

Second code group: First figure indicates weather as in following code: 1—Clear, 2—Part cloudy, 3—Cloudy, 4—Rain, 5—Snow, 6—Thunderstorm, 7—Hail or sleet, 8—Dense fog. Last two figures indicate temperature. Other figures are not important. See H. O. No. 205.

Additional groups refer to upper air conditions.

Missing observations are indicated by the letter "X."

Ship observations are sent as follows: First the call letters of the ship, then a 5 figure group, the first two figures indicating latitude north, last three figures longitude west. This is followed by another group indicating barometer and wind as explained above.

A general summary of N.E. Pacific weather, pressure conditions and forecasts for the Pacific Coast are sent after the ship reports.

The morning bulletin gives land observations for 5 a.m. (P.S.T.) and the ship obser-

uations for 4 p.m. of the previous day. The evening bulletin gives land observations for 5 p.m. and ship observations for 4 a.m. of the same day.

XDA weather bulletins are similar to those of NPG. The name of each observation station is sent, followed by two code groups of 5 figures each.

First code group: First three figures indicate barometer readings in tenth millimeters and omitting the initial figure, which is "7" in all cases. Thus: 638 indicates a reading of 763.8 m.m., etc. The deck officers have tables for translating these readings into inches. The last two figures indicate wind direction and force in same code as given for NPG.

Second code group; First figure indicates weather in same code as given for NPG. Remaining figures are unimportant. See H.O. No. 205, page 113 and supplements.

The forecasts in Spanish cover the east coast and the following west coast zones: West coast of Lower California, north Gulf of California, south gulf to Cape Corrientes, south Pacific coast of Mexico, Gulf of Tehuantepec.

NEON GAS LAMP

By L. W. Gillis

Illustrated by Jack Bront

In the operation of arc transmitters, the problem of "QSB" is a large one. Due to the sluggish action of radiation meters, the operator must rely wholly on the DC ammeter and a detune of his receiver to pick up a harmonic for QSB check. Any operator who has watched the dizzy jerks of a DC ammeter while he detuned his receiver from a "QRZ" station, knows the seemingly impossibility of causing the meter to assume a steady position. He also knows how difficult it is to pick up "QRZ" again in time to hear the signature, let alone the msg.

"QSB" may be controlled to a great extent by the use of a neon gas lamp. These lamps may be purchased at radio stores dealing in "Ham" supplies and usually cost about one dollar. Westinghouse spark plug or the "Aircro" testers may also be used; however, these are hard to obtain as their use seems to be out of vogue in the automobile business. In hooking up the lamp, any lead in the output circuit may be used. The lamp is shunted around a single lead, leaving about 2 ft. between connections, 4 ft. is better. To state it more simply: A point is selected on a lead to which one side of the lamp is connected. At a point on the same lead a distance of from 2 to 4 ft. away, the other side of the lamp is connected.

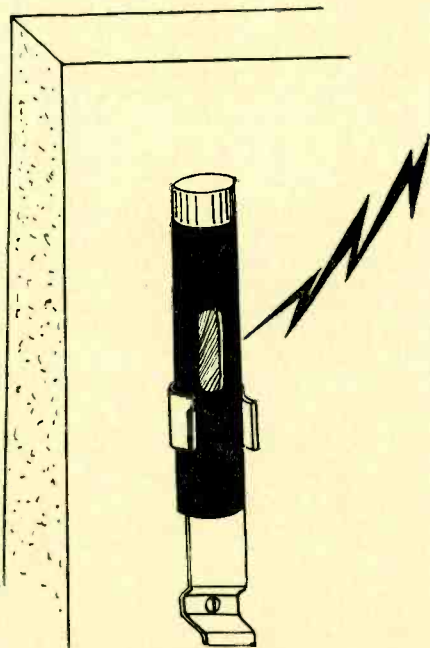

Neon Gas Lamp.

When the arc is in operation, the lamp will glow with a blue-orange color; this glow will vary with the fluctuations of the arc. The current consumption of lamp is approximately 2 milliamps, so little if any radiation decrease is effected. Using a lamp of this type, it is not necessary to watch the DC ammeter nor is it necessary to detune the receiver. The glow variation of the lamp is, to all purposes, practically instantaneous. A steady lamp glow means a pure steady note, variation means "QSB."

THE NEEDS OF COMMERCIAL RADIO

By L. B. Dustin

The needs of commercial radio are so many that Mr. Dustin's article has been divided into three parts, each taking up one of the three sub topics. The first installment deals with transmitters, the second with receivers, and the third with personnel (that as needs it.) It might be felt that this section of Mr. Dustin's article should be directed at the officials of the radio service companies and steamship owners. Correct! And it is. We hope that some few hundred of our readers are on familiar enough terms with these officials to let them know what we as operators think of present day efficiency in maritime radio, and that we are interested in helping them correct and improve their methods and apparatus. Not only that; a good many operators of today will be the chief operators of tomorrow and general managers of next week. Hence . . .

In setting out to enumerate some of the needs of the commercial marine radio "game," I fully realized that it is much easier to criticize than to remedy, and to picture perfection than to achieve it. However, if we can all see the same idea, toward which to work, there is something accomplished. I would like to present such an ideal from an operator's viewpoint.

There are two main elements entering into the rendering of a first class radio service aboard ships. Namely—equipment and personnel. Perfection in either alone is naturally of little advantage, and on the average ship there is much room for improvement in both. No one will deny that marine radio has developed very rapidly, in reaching its present state, but if it is to take care of the increasing demand for ship communication in a fast crowding ether, and at the same time improve its speed and reliability, there is a great deal yet to be demanded.

To begin with the transmitting equipment. The time has been when the trend of development was toward greater power as the only means of breaking through static, and fast increasing interference, in order to maintain communication over long distances. This battle of the kilowatts has exhausted itself today, however, due mainly to the perfection of continuous wave apparatus; the arc, the oscillating tube as transmitter, detector and amplifier, and the natural limitations, aboard ship, of power and aerial dimensions. Even today, however, restraint could well be exercised in the amount of power used in ship installations, as there is very little judgment exercised by the average operator, as to the amount of power necessary for communication without creating unnecessary interference. If the power surplus available, were smaller, in a large number of installations, it would at least tend to limit the jamming which could be caused by a thoughtless operator, and would also tend to develop the operator's ability to get the highest efficiency from his set, and use the most effective procedure in getting traffic off. Limiting the maximum power available would also tend to decrease the evil of working over the head of the nearest coast station. Considering the efficiency of low power quenched spark and CW transmitters, and the sensitivity and selectivity of modern tube receivers, a great number of ship installations could be kept within a few hundred watts or less, and still insure reliable communication, especially

on coastwise and inland water steamers. This would reduce the area of interference on other waves, both broadcast and commercial, in the congested zones along our coasts and harbors which are most productive of harmful interference, and where the need for high power is the least. It might be feasible to classify ship stations, somewhat as broadcasting stations are now classified, regulating the power and waves used according to the service the ship was in, whether river, lake, coastwise, or trans-oceanic, etc., still keeping a universal calling wave for all vessels.

The average transmitter is easily capable of tuning well within the decrement required by law, and need not cause unnecessary interference due to broad tuning, but too often a well designed and tuned set, is experimented with, by the operator as soon as the ship leaves port, still it is a perfect stranger to any civilized decrement. All settings should *always* be marked, and posted, when a set is tuned, so that it could be very easily reset, even by an inexperienced operator, or by an operator who had no access to a wavemeter or decremeter, should he get a set so out of tune that it radiated a broad wave.

Full advantage is not taken at present of the wave range assigned to vessels. Of course it would be nice if there were enough wavelengths to be able to assign new bands whenever one became overcrowded, but this being impossible, the fullest use must be made of the existing ones. Therefore it seems imperative to increase the number of wavelength changes possible within the existing zone. Where a ship transmitter has two or three waves available, i.e., a calling wave, a compass wave, and perhaps one other, there should be wavelength changes every 15 or 20 meters, giving more flexibility, and less congestion on one or two points of the wavelength band. If all transmitters were thus equipped with six or seven wave changes between 600 and 900 meters, sharply and accurately tuned, and *kept* tuned to their allotted waves, a great deal more traffic could be handled, with less congestion than there is at present. A standard wavelength coding system where letters are used to represent a given wave, such as is used by the navy, would be of value in this connection, facilitating quick changes by merely saying "QSY" or "Ans," "A, B or C" as the case demanded.

Another suggestion is that the power control be made more readily adjustable. With most sets it is necessary to readjust three or four elements of the set, in order to reduce power and keep the set in tune and at maximum efficiency for the power used. If the number of gaps are changed, the voltage must be reduced accordingly. Reducing the gaps also changes the tuning of the primary circuit slightly, necessitating changes in the aerial tuning and possibly in coupling, for maximum efficiency at the reduced power, and in order to keep the pure note and sharp wave characteristic of a properly operated quenched gap set.

In many sets these changes can not be made quickly and readily enough that the operator is willing to bother to change power, but prefers to tune the set at a medium or maximum power, and leave it there. Even in sets which use variable impedance in the low frequency circuit, or a switch that shorts part of the generator field to give quick changes of voltage, the number of gaps must still be changed and the clear note is lost unless other adjustments are made. The quick power change in these sets is usually limited to two or three variations, high and low, or possibly medium.

The ideal set should have a continuously yet quickly and easily variable power change, with only one control, which would not destroy the tuning or note of the set. The tube transmitter is more nearly ideal in this respect, where the power output of the set is smooth'y and easily variable, merely through a single control, that of the plate voltage, without noticeably changing the emitted wave, or the

note or efficiency of the set. It is possible, through proper design of spark transmitters to achieve nearly as flexible power control, even though efficiency might have to be slightly sacrificed.

Another point which seems to have been overlooked in designing spark sets is that of spark frequency variation. It is always possible for an experienced operator to read a station whose spark frequency is considerably different from another, even though both be working on the same wavelength with the same audibility. If a wider range of frequencies, easily variable, were available to the sending operator, he could often work through interference which would be impossible where practically all sets have the same note. With a variation of two hundred cycles or less, the amount of traffic that could be handled on a given wavelength could easily be doubled, which would be equivalent to adding another wavelength. In this connection it would be well to equip receiving sets with an audio frequency tuning control, either in the audio amplifier circuit, a resonant air chamber, or a head set whose audio resonance was variable.

Compare the complicated operation of commercial radio sets with that of a Morse wire, where all that is necessary for the operator, is to open and close a single switch. It is possible to make transmitters much more flexible in the above respects, thereby increasing the speed and volume of traffic handled.

Some may contend that the spark set is growing obsolete and that eventually they will be entirely replaced by tube and arc equipment, but there is a big field for low and medium power spark transmitters, for many years to come, on account of their less complicated operation, lower cost and upkeep.

Last, but not least, every transmitting set should be equipped with a break-in system. There is at least one method of break-in keying, which is very positive and effective, practically up to the maximum range of the highest powered marine transmitters in use. This requires a relay, adding another piece of equipment, but this would be an advantage in most cases, as in sets handling over 500 watts, it makes possible the use of a light Morse key or a bug, speeding up the working and improving the quality of the code. The prejudice against using a bug for marine work is comparable to that among a great many "would be" operators on Morse way wires. Their "blessings" of the bug users prove nothing but their own shortcomings and inability to copy anything over fifteen words a minute. Of course no one will deny there are times when it is folly to attempt to use a bug, either on a radio or Morse circuit, and a poor bug sender is worse than the worst fist—Heaven deliver us from either! The man who refuses to attempt to learn to use one, or to read bug sending, might be compared to the man who would walk rather than ride.

(To be continued)

LETTERS TO THE EDITOR RADIO GROUNDS

In the October issue of RADIO appeared a discussion of the comparative merits of various types of ground connections for radio receivers. Certain views were stated by the author which are at extreme variance with accepted principles and would therefore seemingly invite comment, so here is some more discussion which may or may not be of interest to your readers who have given the subject more serious thought.

Recommendation is given to a ground clamp having a pointed screw as giving an almost perfect contact. This does not seem logical since the surface in contact with the pipe is very small, compared to the several square inches of surface presented by the strap type of clamp.

Further on is mentioned the fact that the ground lead from a lightning arrester should be insulated from the wall so that in case

lightning should strike the aerial, a fire would be avoided. Now I am wondering if this writer has ever visualized the probable result of a direct discharge of lightning through the average "angel trap"? It is certain that No. 12 copper would not conduct the several thousand amperes to earth, and this becomes more apparent to anyone who has seen several blocks of No. 4 transmission line ionized by a direct hit. Anyway a lightning arrester was never intended to bear the brunt of direct discharge, but to conduct to earth the static charge accumulated on the antenna by providing a path of lesser resistance than through the receiving instruments and incidently reducing the potential gradient in the vicinity of the station and thus lessening the possibility of a direct discharge at that point. This was also the function of the old time lightning rod.

Now the statement is made that the connection should be made to the water pipe at the point on the pipe that approaches nearest to the receiver. As the ultimate object of a ground lead is to make connection with the earth with the least possible resistance, wouldn't it be much better to provide a copper path to the point where the pipe enters the earth, and thus eliminate the possibility of resistance at rusty pipe joints and the resistance of the iron pipe itself, which is greater than copper.

As we review the article in question further, a bunch of junk buried in moist earth is championed as being superior to a water pipe, which is usually part of a city water system comprising a network of metallic conductors covering several square miles, and in most cases buried at least three feet deep. An equal amount of junk buried in the back yard would require quite an excavation.

Now if one were to do as suggested and solder a wire to each piece of metal and bring these wires into the house with the idea of getting them all wrapped or otherwise fastened to the average hinding post, difficulties would surely be encountered.

Now the discussion of the "Round ground," which, before going further, appears to the writer to be merely a combination of capacity and conductive ground, and used principally for radio transmission, although no doubt it would work admirably in connection with a BCL installation. It is stated as a fact that in a multiple ground connection that at each additional ground connection a little radio energy is leaked off—where to? Back into the ground? That doesn't set well, since in regard to the received radio wave at any particular instant, the earth within a reasonable distance is at practically the same phase relation and therefore at the same potential, and we all know that to *leak* there must be a voltage difference, and if you did spread the separate connections out far enough to get a potential between them, and the lead was at the center of the system, as is the case with the Round ground, you would have the mean or average voltage at that point due to the phase difference between the two ground connections. All this is of course based upon the action of the ground wave only, and that seems to be the one we are mostly interested in at broadcast frequencies. And then, what is gradual, or slow leakage of a radio wave? We thought they traveled 185,936 miles per second, always, with no time out for lunch.

And here comes our old friend, the counterpoise, which has been the subject of much discussion recently in connection with radio transmission and reception, especially on short wave, and I think we might as well concede that there is only *one* type of counterpoise and it is insulated from the ground, forming one side of a series condenser of which the earth is the other side. Of course it is possible to have bad insulation in this condenser just the same as we sometimes have molded mud end plates in the variable type, and who ever

(Continued on page 56)

With the Amateur Operators

A FLEXIBLE LOW POWER TRANSMITTER

Arthur Martini, 6 CHL

This transmitter was designed by a ship operator and built by the writer. It provides for low power auxiliary or emergency transmission on the marine 600-800 meter band and can be converted instantly for long distance transmission on the 40 meter band. Surprisingly good results have been obtained on both wave bands. Some interesting facts in connection with antenna size for short wave work turned up in the development of the transmitter. At first, an ordinary sized amateur antenna was erected for the 40 meter work but tests soon developed the fact that signals at very distant points were upwards to four times or more stronger when transmitting on the big ship's antenna.

On the 40 meter band, using inductive coupled Hartley circuit and a small antenna, the signal strength between Yokohama and San Francisco was on the order of R-1 to R-3. On the big antenna the signal strength was R-6 and R-7. The true antenna current is not known as no attempt was made to locate the nodal point for placing the antenna ammeter. With the meter in the position shown the current was 1.5 amps. on the small antenna and 0.5 amps. on the big antenna. Many tests were made and it was definitely established that signals were always at least twice as strong on the big antenna and generally four times as strong.

There is nothing especially novel about the set except the two widely different wave bands covered. The pictures show most of the details and construction data will not be given as no good amateur ever follows them anyway.

A report of the performance might be interesting. With 500 volts plate supply on two UX-210 tubes working into a direct coupled Hartley circuit on the 600-800 meter band, reliable daylight communication with ship and shore stations has been maintained up to 500 miles. No special effort has been made to work DX on these waves but the operator says that on several occasions good night communication was effected at distances of 1000 miles and once or twice better than 2000 miles. He says the set is almost as good as the 2 k.w. spark outfits installed on most cargo boats. Why not something like this set for the trans-ocean airplanes? Work nearby ships on 600 and distant shore points on 40. I should think a plane could drop a long enough trailing antenna and the antenna swing don't seem to matter much on either the long or short wave band.

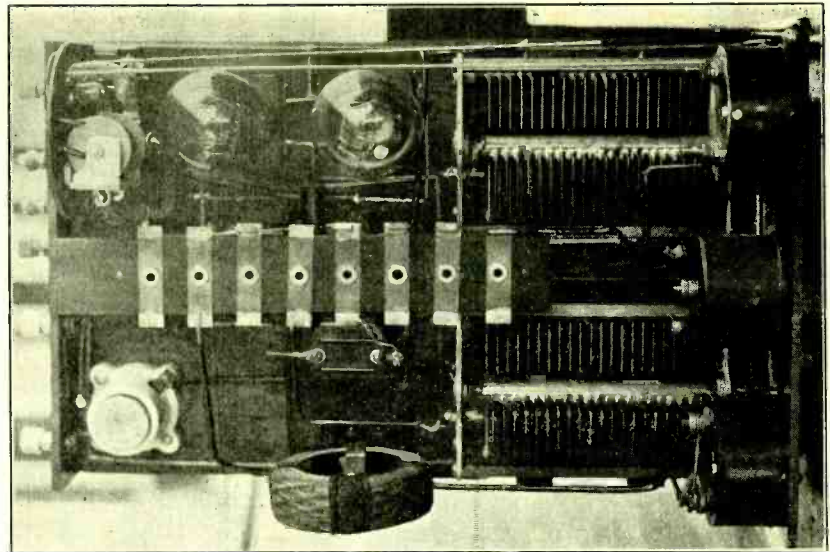

Top View of Transmitter.

The antenna now used with the set is an average cargo boat type, 4 wire T, wires spaced 3 ft; 240 ft. long, average height 65 ft. above water line, 35 ft. lead-in to the set and approximate fundamental wave length 325 meters. Lead-in is in the center of the T.

On the short waves, reliable nightly communication has been maintained on the ship's run between San Francisco and Japan, the set putting an R-6 signal into San Francisco from alongside the dock at Yokohama. Except for one or two nights in dead spots on the Mexi-

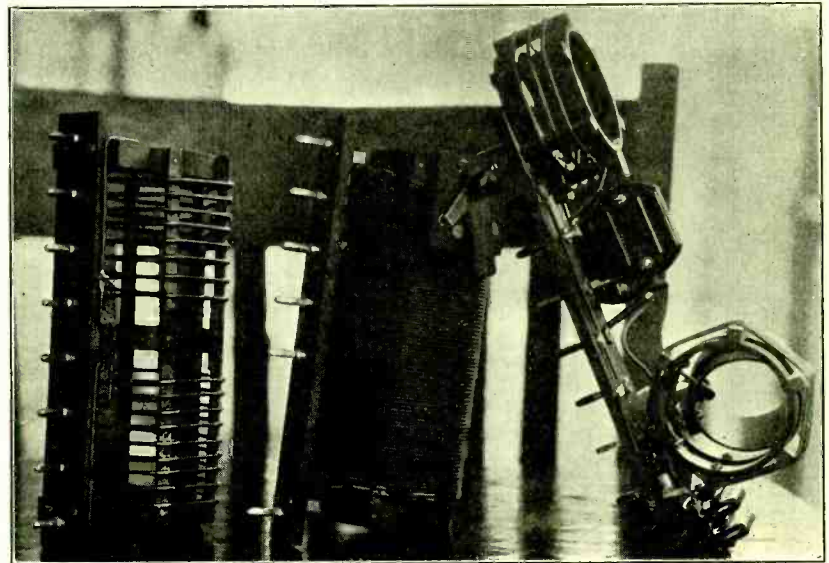

Coils for Transmitter.

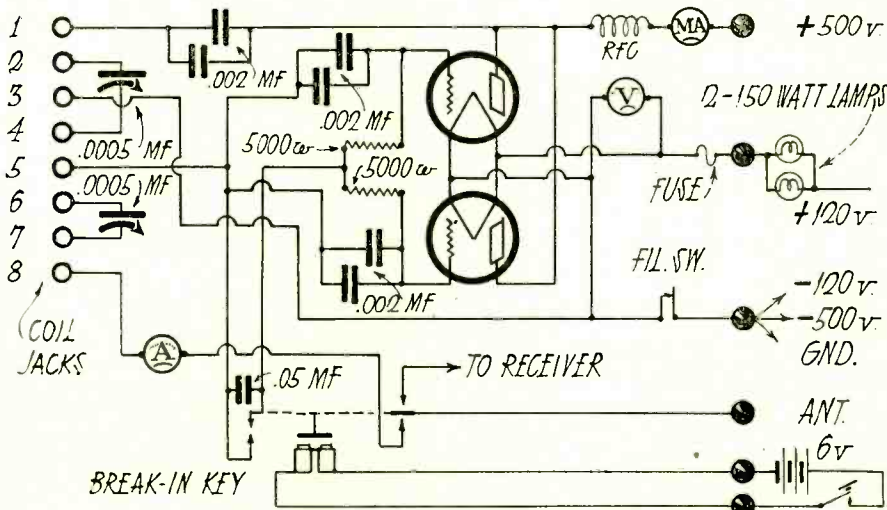

Fig. 1. Circuit Diagram of Transmitter.

can west coast reliable communication was maintained on the run from S. F., through the Panama canal and to Atlantic coast ports with signals R-4 to R-7 in San Francisco.

It was at first thought that the roll of the ship would cause bad swinging on the 40 meter band but very little trouble was had in this respect. Some signal swing is noticed when the antenna and primary circuits are in exact resonance but with the antenna circuit tuned slightly above resonance the signals are perfectly steady even when the ship is rolling badly.

The transmitter and the Hartley coils for the two wave bands are shown in the pictures. All coils were wound on 3 in. skeleton tubing. The third coil was designed for the tuned-grid tuned-plate circuit, but to date no success has been had with it. The operator reports that with this coil the set puts out a terrific audio frequency howl but nothing else happens. (Hi)

The narrow front panel was necessary as the set had to be designed to fit a space 10 in. wide. The grid leaks are under the coil jack strip and do not show in the picture. The two

Mazda lamps in the filament circuit are mounted on the rear of the cabinet. They cut the 120 volt supply to 7 volts at the tube filaments. Care must be taken not to turn on the filament supply unless both transmitter tubes are in their sockets or a burnt out tube and voltmeter will result.

The break-in relay key is made of a Yaxley power control switch with connections arranged as shown in the circuit diagram. The metal housing and base of the switch is removed and unnecessary wiring cut away. The contacts should be adjusted so that the pair in the antenna circuit close a trifle in advance of the power contacts. These relay switches will follow very rapid key action and on tests have handled up to 300 milliamps on the power contacts and 2 amps on the antenna contacts.

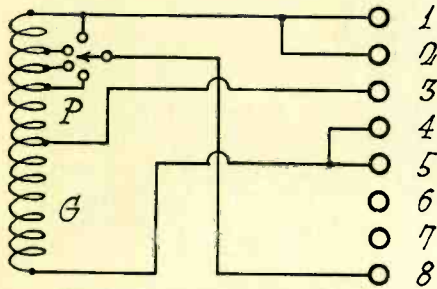

Fig. 2. 600-800 Meter Coil Plug.

80 turns No. 18 bell wire. Filament tap in center. Antenna taps—one on plate turn and then three taps 7 turns apart in from plate turn. Ant. coil, 8 turns; plate coil, 3 turns; grid coil, 6 turns. Turns spaced 1/4 in. Coupling 1 1/2 in.

The r.f. choke coil is a 300 turn Giblin-Remler Inductance coil and the same choke is used for the two wave bands. Smaller chokes were tried for the 40 meter band but results were about the same as with the big choke.

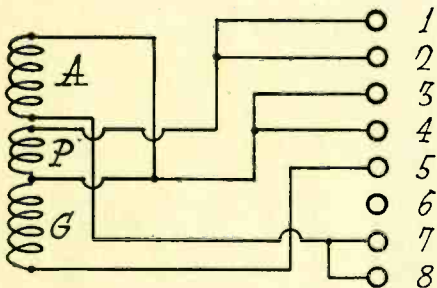

Fig. 3. 40 Meter Coil Plug.

Ant coil, 8 turns; plate coil, 3 turns; grid coil, 6 turns. Turns spaced 1/4 in. Coupling 1 1/2 in.

The condenser settings and tap switch adjustments for the various waves in the 600-800 meter marine band are found with a wavemeter or the secondary circuit of a calibrated receiver. Find the tap and condenser setting which gives the maximum antenna current with a minimum reading on the milliammeter for each wave. A spot will be found on the 2nd tap (14 turns in from the plate tap) where the plate current will rise sharply

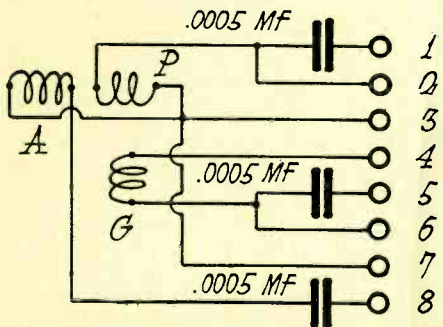

Fig. 4. Tuned-Grid Tuned-Plate Coil.

Ant. coil, 8 turns; plate coil, 3 turns; grid coil, 3 turns.

PARTS LIST

- Total cost—Approximately \$100.00
- 1—Panel, 7x10x3/16. Condenser scales engraved
 - 1—Binding post panel, 2x10x3/16.
 - 1—Wood baseboard 10x14x1/2
 - 1—Milliammeter, scale 0-500.
 - 1—Voltmeter, scale 0-10
 - 1—TC antenna ammeter, scale 0-2.5
 - 1—Filament switch, heavy duty type
 - 2—Pointer knobs
 - 2—Variable condensers, transmitter type, .0005 mfd.
 - 6—Fixed condensers, Sangamo, .001 mfd. each
 - 1—Fixed condenser, Sangamo, .05 mfd.
 - 2—Transmitter grid leaks, Ward Leonard, 5,000 ohms.
 - 1—Coil jack strip, bakelite, 1 1/2x9x1/4
 - 8—Coil jacks, General Radio
 - 2—UX sockets, Remler
 - 1—Giblin-Remler Inductance Coil, 300 turn.
 - 3—Lamp sockets.
 - 2—150 watt mazda lamps.
 - 1—Fuse plug, 3 amps.
 - 8—Binding posts
 - 1—Hand telegraph key
 - 1—Yaxley power control switch, type 444.
 - 2—UX-210 power tubes
 - 10—Ft. buss wire and spaghetti
 - Hartley coil parts
 - 6—Bakelite rings, 2 1/2 in. diameter. 1/2 in. wide
 - 12—Bakelite strips, 7x1/4x1/4
 - 2—Bakelite strips, 8x1x3/4
 - 14—Coil plugs, General Radio
 - 50—Ft. No. 18 bell wire, double waved insulation
 - 20—Ft. No. 14 bare copper wire
 - 36—Machine screws, 4-32 thread
 - Bakelite scraps for spacers, tap switch, mounting, etc.
 - 4—Inductance tap switch points, switch blade, etc.

with excessive tube heating. This spot should be avoided and the 600 meter setting found on the first tap where plate current will be low. Following are the adjustments with the antenna described:

Tap	Cond	Wave
1	82	600 Calling and distress wave
1	100	650 Working wave
2	65	675 Working wave
3	65	700 Working wave
3	85	735 Working wave
4	72	750 Working wave
4	100	800 Radio compass wave

On the 40 meter band the adjustments are very simple. The calibrated receiver is set on the wavelength it is desired to use—anywhere from 32 to 46 meters. The filament switch of the transmitter is then cut in and with the key down but plate power off, the primary condenser is varied till the signal is heard in the receiver. The plate power is then cut in and the antenna condenser adjusted for maximum antenna current. For the steadiest wave the antenna condenser is increased 5 or 10 degrees until the antenna current falls off about one-tenth ampere. The whole tuning operation can be done in a few seconds.

CALLS HEARD

By G-6PP, 54 Purley avenue, London, N.W.2., England:

1gp, 2abc, 2afv, 2agu, 2avr, 2bed, 2cuq, 2exl, 2mu, 2sz, 2ub, 3ajx, 3buu, 3chg, 3sh, 4acz, 4ob, 8bpd, 8ccs, 8cnt, 8dpj, 9bgq, nclda, nc3zb, nq7cx, sblem, foa9a, kfzq. Qrk mi 45 mtr dc sigs?

By NU-8CFL, C. C. Justice, 433 South 17th St., Columbus, Ohio. (August 6 to Nov. 1), 20 meters: lamd, layg, laxq, laiq, lasu, lawe, 2bat, lbms, 1bqs, 1byv, 1bux, 1cfo, 1cpb, 1dm, 1fl, 1hh, 1ii, 1ki, 1lu, 1kl, 1nf, 1nv, 1sz, 1uw, 1uv, 2agn, 2apl, 2acy, 2awx, 2awq, 2cvj, 2md, 2or, 2tp, 2va, 3af1, 3ccc, 3nr, 3sh, 4ec, 4km, 4qy, 5aeb, 5aeg, 5afp, 5agq, 5aiq, 5akp, 5apo, 5ara, 5bh, 5dx, 5kh, 5lf, 5lm, 5pt, 5sh, 5wz, 5zk, 5zav, 6agr, 6axg, 6ann, 6bfb, 6bjh, 6bq, 6btz, 6bdz, 6bzt, 6bux, 6brd, 6cdw, 6cfw, 6col, 6cuc, 6cyx, 6czl, 6csj, 6dch, 6dhn, 6dhs, 6dan, 6vc, 6vz, 6wb, 6gw, 7add, 7vh, 7ek, 7vz, 7dd, 9aok, 9asc, 9bbt, 9bca, 9bnd, 9cbb, 9cei, 9edw, 9car, 9crd, 9cvn, 9cpf, 9dps, 9dpw, 9drv, 9dwn, 9dws, 9dzi, 9ehi, 9ek, 9hl, 9rg, 9ux, nclap, nclbr, nclbt, nclco, nc2be, nc4cp, nc4dw, nc4fv, nmcy, np4ach, np4kd, nr2fg, eb4ww, eilcr, sada8, sb1aa, sb1ad, sb1aw, sb2ar, sc3ag, su2ak, wnp, wbd.

(40 meters), nc9aj, nclap, ndhik, ne8ae, nm1aa, nm1g, nm1k, nm9a, nn1nic, nq2ac, nq2cf, nq2jt, nq2ro, nq5a2, nq6by, nq5ev, nq5ry, nq7cx, nr2ea,

nze25, eb4ww, eb4zz, ef8ku, eg6ya, lnoja, xenoqq, sbiah, sb1ao, sb1aw, sb2ay, sb5aa, sb6qa, sc2bl, se1fg, se2bn, svlxc, filab, iqpm, oa6ax, 7oa5ma, oh6dv, oz2ac, oz2al, oz2bg, nrcto, nr2fg, kfzq, klif, pty, ip1, sb2ar.
Qrk mi ex-310 on 20, 40 and 80 meter bands? Will qsil all crds.

At 2WZ, 2BGK, 654 East 23rd street, Brooklyn, N. Y.; and NO3AOC, 438 Pyne Hall, Princeton, N. J.

USA: 6ahi, 6bbi, 6bfq, 6bjq, 6bnx, 6cct, 6enk, 6cto, 6dgy, 6dli, 6ay, 6wb, 6xk, 7aad, 7bq, 7iq, 7mg.

NC: 1ar, 1ap, 1ax, 2al, 2bb, 1br, 2do, 3gg.

Er: oja.

Fo: a4xa.

NN: 1nic.

OA: 2gc, 2yi, 3es, 3wm, 5dx, 5mb, 5os.

OZ: 2wa, 2xa.

SU: 1ga, 2ak.

Wnp, wktl.

By 2WX-2BGK, 654 East 23 St., Brooklyn, N. Y. 3AOC, 438 Pyne Hall, Princeton, N. J.

Ea-cm, eg2ky, ei-1er, ei-1fo, eplaa, nb-be3, nc-lak, nc-lac, nc-lbi, nc-lbr, nc-ldm, nc-2an, nc-2bo, nc-2br, nc-2cw, nc-3cj, nc-3cs, nc-3hp, nc-3gg, nc-3md, nc-4ck, nc-4ek, nc-4gb, nc-5ef, nc-5go, nc-9co, nn9co, nn1nic, nrcto, nr-lur, nr-2ea, nq2ac, nr2fg, nr2ags, nq2ac, nq2cf, nq2jj, nq2fa, nq5in, nq5gy, nqixl, nq7cx, oa2mh, oa2wc, oa3vm, oa3wm, oa3kb, oa5cm, oa7es, oz2go, oz3au, sb-iah, sblic, sblab, su2ak, xnn-bx, xek-j2, ixcu, l8o, wnp, wye, wyi, ir-1.

U.S.A.—Six—6aae, aak, abm, abq, ad, agg, agr, 6ahs, 6aik, aid, am, amw, ank, aqm, ato, atu, awm, bab, bag, batj, bax, bbr, bd, bfq, bsp, bgv, bjh, bji, bjq, bk, bnx, bo, boe, btn, bug, bwk, cay, cla, cmx, enx, coi, cty, csl, ccyx, czm, dau, dcu, dfg, dfs, dgy, dh, dhj, dhq, dhu, dje, dju, dkt, dkx, dli, dls, dmw, dnh, dns, dpf, dpk, dpm, dqd, drh, dz, er, eu, fa, id, ix, jn, kn, kz, gw, lo, lx, px, qi, rn, tj, ty, ud, vt, 6zo.

Seven—7acy, adx, afo, ajk, akx, ajb, al, arz, eis, bx, eo, mc, mx, ob, og, ok, rh, sp, ti, 7wb, 3caa, 9eam.

By 9APY, 3337 Oak Park Blvd., Berwyn, Ill. 1AMD, 1AQF, 1BKE, 1CKB, 1CJC, 1FS, 2AHM, 2AVK, 2AYJ, 2BM, 2CC, 2CRB, 2CUQ, 2GP, 2OR, 2QH, 4UM, 4TK, 5AAV, 5ANE, 5MS, 5QJ, 5RG, 6AAK, 6ABG, 6AGR, 6ALR, 6AWY, 6BRD, 6BTX, 6BVV, 6BXN, 6CAT, 6CCT, *CPR, 6CUB, 6DOG, 6RN, 6VQ, 7ADD, 7FB, 7VU, 6EW, KZET, PJC, Xenogvq, nm1G, oa2TO, oa2UI, oa2YI, oa3ES, oa3WM, oa7CW, oh6BDL, oz4AC, nc4GT.

By EQ-GBZW, Harry E. Smith, 31 Wandle Rd., Hackbridge, Surrey, England. From January to June.

First District—axa, ani, amu, asi, aao, aap, aof, apf, axo, axx, air, azr, ag, ajm, adm, aox, aur, asu, alr, avp, aci, aer, aqi, aux, ajm, alf, abt, aba, ac, ach, bhm, bvl, bfx, bkc, byv, bke, bms, bem, bez, bbs, bxh, bak, bux, bhs, ce, cr, cd, ch, chr, cnz, cjc, cnp, cc, cti, cmx, cdp, cfo, bfl, cx, bez, caw, cab, ckk, cjh, cx, car, de, di, ga, gr, yb, kk, xj, in, on, ur, zs, kp, vz, uw, zl, id, rd, ic, is, ja, kf, lj, vz, xm, ud, qb, pm, vc, ka, ro, ry, zz, mv, hj, dh, xg.

Second District—are, atw, atk, atx, aih, aki, ag, ait, akv, arr, auv, afv, avh, apb, awq, ahm, aiu, agu, akz, ayz, aep, awu, adl, agn, ayb, aas, ajf, au, anx, ane, anq, apd, auv, ayg, abp, ah, agx, avw, ahm, aer, apa, baa, buy, bz, bur, bui, bal, cuo, cjb, cdr, cvj, evs, ced, ch, cyq, emm, ctn, jn, fo, gk, gv, hc, ie, od, pp, rs, sj, ty, uk, dg, fa, fc, wc, mu, qf, dh, db, lo, or, ow, nz, va, hy, gp, ot, ld.

Third District—ahl, auv, acm, agg, ajc, alq, afu, ads, avw, aqw, ag, aks, ajl, agv, arw, au, bwt, bms, btq, bss, ce, cj, cch, cbu, cah, cgc, cfm, tu, pf, qh, gp, sj, ft, wf, ds, qj, mb, kr, ee, kx, nr, ob, nr, ft, rz, wqf, mw, mv, ef.

Fourth District—aae, aah, apa, ak, dm, rm, dv, sl, hx, ic, io, ft, wj, hz, fe, sf, tz, ua, hi, nh, eh, bn, tr, xe, iz, ll, gd, if, jm, jk, dd, it, ir, oc, si, tu, bl, tv, jr, rr, wh, tn, lm, sa.

Fifth District—ain, ajs, auu, akk, oa, jf, wz, acf, agq, ax, epb, ql, au, kc, auc.

Sixth District—am, bhv, jn, cfo, hg, hb, cka, ciw, oi, beh, axd, abc, ha, bhr, aix.

Seventh District—ag, wc, gj, wu, sk, no, alk, cs, im, adg, na.

Eighth District—agl, alu, ans, axx, adm, ag, afa, anc, axa, aul, ahe, acy, auh, aef, aj, baj, boy, bet, box, bdp, bau, bag, ax, gj, dgx, dkk, nt, ka, cyi, li, dme, zg, vs, eq, bff, csr, ic, dq, cdv, qh, ce, cdb, gk, cil, dhx, ex, drj, ded, cfr, rh, cau, bsc, li, cpf, bzu, bmr, qb, ck, ddn, djg, dpn, dvj, bcm, sf, ccq, wx, vk, dsy, vx, bsz, cvs, ov, wo, qz.

Ninth District—abb, abn, aeb, arn, auu, axb, awa, aib, arl, aji, ara, anz, aol, agq, aud, awb, aex, ay, bpb, bjw, bud, bsa, bac, bbn, be, bfo, bmx, bpm, bht, bre, bcl, en, cca, cmc, cdy, crp, cxx, cet, cwm, cex, ctg, dns, dka, dr, dkc, dng, dsr, cpm, ddz, dbv, dbw, drd, bd, dga, lb, kv, ez, emb, dkk, mn, sa, xi, kd, ecb, ph, sd, eev, za, elk, zc, fo, lf, idk, xm, bd, ark, dij.

OH—6acc, 6bcg.

Will send report to any whose calls are listed.



AT THE PEAK OF RADIO DEVELOPEMENT

The average autoist will never own a Rolls Royce or Locomobile The average radio user will never own and operate an Infradyne . . . He will never know the supreme thrill and satisfaction of superb performance because he is satisfied with average results . . . When he buys a set, he does it on the "say so" of some friend. He is sold on some one feature or some "trick" selling point. This advertisement is not written for him But one man in seven is distinctly out of the ordinary . . . He demands the best and is never satisfied until he gets it He insists on more than average results . . . He is the man who is making the Infradyne the outstanding success of the 1928 season. He knows that the Infradyne principle is far in advance of the ordinary radio circuits . . . He knows that tested Remler parts are absolute assurance of satisfactory, trouble-free operation. He knows that, with these parts, he can build the Infradyne in a few hours. And, on top of all this, he realizes that the Infradyne costs fully a hundred dollars less than any factory set which even claims to compete with it If you are this "one man in seven," use the coupon below and get the full Infradyne story.

The 1928 Infradyne is available in Kit form. Four Remler units, costing \$149.50, plus a few minor parts and the usual accessories, will give you the radio set that for years has been the ideal of the real radio enthusiast.

The 1928 Infradyne

If you do not want to build your own Infradyne, write us for the name of the nearest professional set builder who can do it for you at a minimum cost. We have lists of thousands of set-builders, many of whom are Infradyne specialists

REMLER

DIVISION OF

GRAY & DANIELSON MANUFACTURING COMPANY

260 FIRST STREET, SAN FRANCISCO

NEW YORK

CHICAGO

Eastern Warehouse: Elkhart, Ind.

REMLER DIVISION, GRAY & DANIELSON MANUFACTURING CO.
260 First Street, San Francisco, California

Please send me complete information about the Infradyne and folder describing all Remler Parts.

Name _____ Street _____ City _____ R.1-28

Tell them that you saw it in RADIO

BETTER LOUDSPEAKERS

(Continued from page 24)

MAGNAVOX

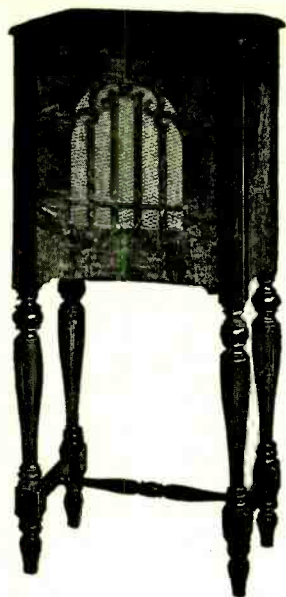

Dynamic Power Speaker for new all-electric A-C Sets

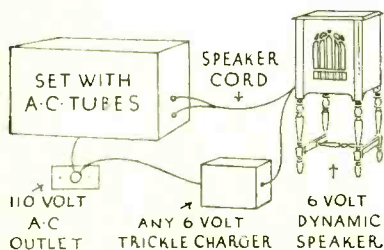

HOOK it up like this sketch because the 6 volt rectified output of any standard trickle charger or "A" rectifier will energize the field of the *Magnavox* 6 volt Dynamic power speaker unit.

Aristocrat Model speaker (complete unit), illustrated above, \$85.

Beverly Model table type complete, \$65. Unit only, (type R-4, 6 volt) \$50. Fits any standard cabinet.

Only the Dynamic type speaker can bring out the full qualities of reproduction demanded today.

Write for speaker bulletins
THE MAGNAVOX CO.
Oakland, California

onant bumps are very much less noticeable than in the case of the magnetic type and can be nearly eliminated by sacrificing some sensitivity. The small angle cone also has a tendency to act as a horn for the higher frequencies since most of the sound energy originates near the apex in a manner similar to the large shallow cones, though not to nearly the same extent, because the smaller cone is more rigid. This effect as a horn seems to give all dynamic speakers a rising high frequency characteristic generally with a peak at about 3000 or 4000 cycles. The horn effect also gives it a very slight directional effect which is hardly noticeable to even a well trained ear.

The hump on the high frequencies can be readily eliminated by means of an equalizer. Curve *B* was taken with this equalizer connected in place. Another and perhaps most important duty of the equalizer is to purify the tone for low frequencies. While the tone from a dynamic speaker is very much purer than that from a magnetic type, especially at the lower frequencies, there is present a second or third harmonic which disappears in listening tests when the equalizer is placed in the circuit. The volume on music is the same when the equalizer is on or off but there is just a shade more of exquisiteness present with the equalizer in place.

Another advantage of the dynamic speaker is that it presents more of a resistive load on the audio amplifier in a radio set or phonograph with a possibility of less audio regeneration and peaks in the audio amplifier characteristic curve. A magnetic speaker has very little reactance on low frequencies and a great deal on the higher notes so has plenty of chances for causing the above distortion. The dynamic type acts nearly as a pure resistance load on the amplifier, since the moving coil has relatively only a few turns on it with quite a large air gap to the nearest iron. In order to match the impedance of the power tube to the moving coil, a step down transformer is necessary, one having a ratio of 25 to 1 up to 30 to 1, preferably with taps for different types of tubes. The equalizer should be built into the speaker which may be used with a baffle board or in a cabinet.

A baffle board or special cabinet is necessary in order to prevent interference of sound waves from the back surface. According to C. W. Rice, the baffle board or cabinet must make the shortest air path between front and rear surfaces of the cone, at least a quarter wavelength of the lowest frequency to be reproduced. The diaphragm and the "spider" apex support may be made to have a very low natural period of 25 to 30 cycles and so bring up the response on the very low notes.

Tell them that you saw it in RADIO

SANGAMO

AUDIO TRANSFORMERS



for REAL realism

Flawless realism in reproduction! What radio enthusiasts and music lovers have hoped for and radio engineers have striven for since the inception of radio.

A dream that is coming true! The new Sangamo Transformer will help. Every tone over the entire musical scale is amplified uniformly. With proper transmission, an appropriate circuit, Sangamo Audio Transformers and a good reproducer the result is flawless realism . . . even to the ear of the trained musician.

3 to 1 ratio

Price \$10

Sangamo Mica Condensers are accurate and stay accurate

Sangamo Electric Company
Springfield, Illinois

New LOG BOOK Now Ready

A clever log book giving spaces for logging dial setting for any U. S. or Canadian station. Also a complete list of all stations by call letters. A separate list of stations by states. Another list of stations by meters, starting at low wavelengths in numerical order. A directory of stations. Calls, waves, kilocycles and meters in alphabetical order. Printed on bond. Handy size. The best 25 cent investment you can make. Limited edition. Order your copy NOW.

25c PER COPY POSTPAID
PACIFIC RADIO PUB. CO.
Pacific Building San Francisco

THE LYNCH NATIONAL 5

(Continued from page 40)

indoor antenna about 20 ft. or so in length. In such a case, the antenna should be connected directly to the mid-tap on the antenna inductance and the small series condenser not used. For other than just local reception, a single wire outdoor antenna of between 50 to 75 ft. is recommended. Such an antenna should be connected through the variable antenna series condenser, which latter instrument should be adjusted until the two tuning dials will read reasonably near alike when tuned to any station.

If the radio frequency tube tends to oscillate, as can readily be told if the set squeals when a local station is tuned in, the tickler coil turned at right angles to the detector grid coil and the volume control rheostat turned about $\frac{1}{2}$ of the way "on," then either too much *B* voltage is being used on the r.f. stage, or else a larger size (higher resistance) grid suppressor is needed.

Although there are several new forms

- LIST OF PARTS USED**
- 1—Lynch "Deck"
 - 1—Pair National tuning units
 - 1—.001 mfd. Sangamo fixed condenser
 - 1—Carter combination 10 ohm rheostat and filament switch
 - 1—Precision No. 940 midget condenser
 - 1—Lynch equalizer, type 4/5, with mount
 - 1—Lynch 1000 ohm suppressor, with mount
 - 10—Eby binding posts
 - 1—Set matched CeCo tubes for Lynch Five including 1 K, 1 H, 2 G and 1 J-71
 - 1—National tone filter
 - 1—National B-power unit, type 7180
 - 1—Exide A battery
 - 1—National Drirex trickle charger with relay
 - 1—Lata Balsa reproducer kit
 - 1—45 volt C battery

term that it has been on the market is the Drirex full wave trickle cartridge such as used in the National Charger.

In selecting a B-power supply, it is important to obtain one designed to operate satisfactorily on a resistance coupled amplifier. Due to the very uniform amplification of all audio frequencies of which this system of amplification is capable, only a B-eliminator of the better type should be considered. Anything less will have its bad points shown up, especially in the case of

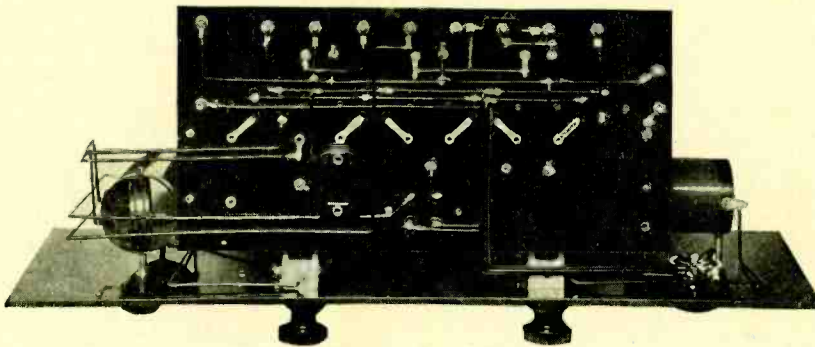

Bottom View of Lynch National 5.

of *A* eliminators which have attracted considerable attention, there are indeed very few if any which can outclass the storage battery trickle charger combination when it comes to reliable and economical noise-free service. Of late, there have been a number of new and somewhat revolutionary developments in both high and trickle rate rectifiers and chargers which make this system even more desirable.

One such development that has attracted much favorable comment from all parts of the country during the short

"motor-boating." Should a slight "motor-boating" be experienced it may readily be corrected by trying several different values of grid resistors in the resistance coupled amplifier.

Another suggestion is to connect a 4 mfd. condenser from the $+B$ detector post to the $-B$ post at the set, not the power unit. In the most obstinate cases, it may be advisable to use a grid impedance, such as the National, with its special cord and plug for easy connecting in place of the grid leak to the last or 171 power tube.

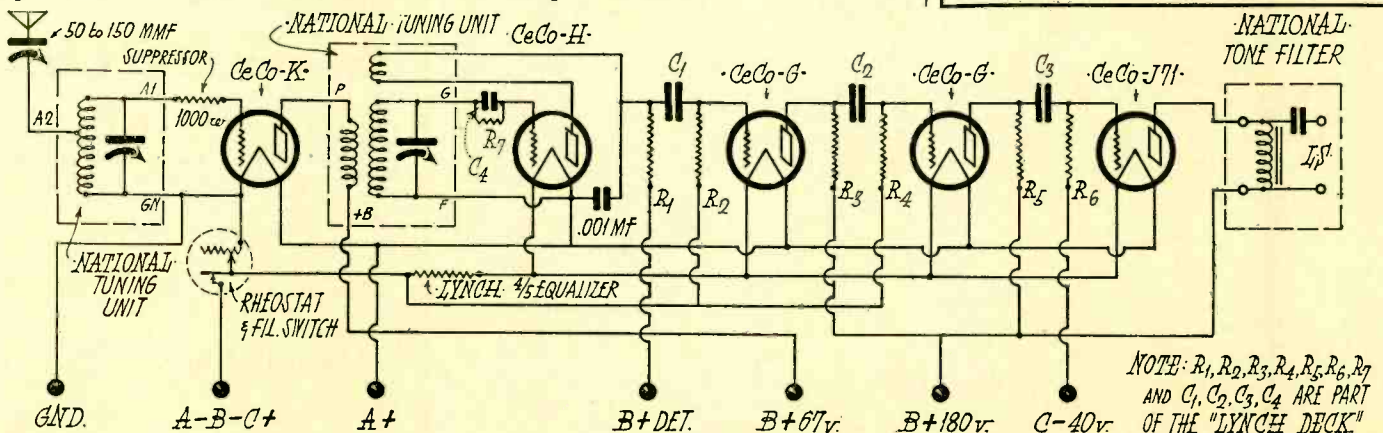

Circuit Diagram of Lynch National 5

Tell them that you saw it in RADIO



NOW

That Everybody

Demands Electrically - Operated Radios Dongan is in Production on All Types of A. C. Tube Transformers!

Today you can secure from the production line Transformers and Power Supply Units for whatever type of A-C or A-B-C Tube you have chosen. For Dongan has been in production on approved types for many months.

Here is the Newest

No. 6515 Transformer for use with 4 UX 226, 1 UY 227 A-C Tubes and 1 UX 171 Tube. Together with a B-Eliminator, this new transformer will convert old type set into an efficiently operating A-C set.

\$4.75 list

This is one of 14 types ranging in price from \$3.50 to \$8.00 for use with the new types of A-C Tubes.



No. 5553 A-B-C Power Unit for UX 226, UY 227, UX 171 and UX 280 Tubes.

\$22 list

Manufacturers are invited to write for any kind of information from our engineering department.

Fans — order from your dealer or send check or money order to factory direct.

Dongan Electric Manufacturing Company

2981-3001 Franklin Street

Detroit

TRANSFORMERS OF MERIT FOR FIFTEEN YEARS

THE 115 K. C. SUPER

(Continued from page 21)

Next line up the three gang condenser with the adjusting handle furnished with the condenser, turning the set screws on the mica trimmers which are located underneath each gang in the condenser unit, until the station is heard at maximum volume. Move the tuning dial back and forth after each adjustment, to see if the tuning becomes any sharper as the unit is lined up. This adjustment should be made at about the center of the broadcast waveband, and then a station at both the lowest and highest limits of the waveband should be tuned in, and the process repeated, noting any difference in the adjustment of the trimmers, so that an average adjustment for the entire band can be obtained.

After the r.f. dial is lined up, note whether the oscillator dial setting for any given station is approximately the same as the r.f. dial setting. If it is widely at variance, the oscillator is being operated on the wrong side band. Since the two side bands are 230 kilocycles apart, with an intermediate frequency of 115 kilocycles, the first setting of the oscillator when testing may be the wrong one, so that both settings should be located, and the one selected which is nearest the r.f. dial setting, this usually being the lower one. Now adjust the compensating condenser fastened to the oscillator variable condenser, with the adjusting handle furnished with the three gang unit, until the settings of both dials are the same. It will then be found that the settings will be within two or three degrees of each other over the rest of the scale.

No trouble due to harmonics of the oscillator will be had with this receiver, because the r.f. amplifier is so selective that it will not permit frequencies 230 kilocycles above or below the station being received, to enter the mixer tube, and hence there will be no squeals or whistles in the set which can be varied in pitch by turning the oscillator dial back and forth. Whistles which may come in with the station are caused by heterodyning between distant stations operating on the same wave, so that the blame may be laid to the radio commission and not to the set, if the whistles are heard.

If the oscillator dial settings are found to be broader than expected, it may be due to slight variance in the peak frequency of the three intermediate coils, and this may be quickly determined by turning the set screws located on top of the coils, while the oscillator dial is at resonance, and noting if any increase in volume is heard. Adjust the set screws to the point of maximum volume, and turn the oscillator dial back and forth after the amplifier seems to be lined up, to make sure that the selectivity is good. The sensitivity knob for the interme-

mediate amplifier can be turned to maximum without oscillation, and under ordinary circumstances may be left in that position.

Exclusive of the audio amplifier, for which many builders will use a separate unit, the cost of the parts used in this set is less than \$110. Using the audio transformers, etc., specified, add about \$22 to the cost if included as an integral part of the receiver.

THE TRANSMISSION UNIT

(Continued from page 22)

is of interest to know how these measurements may be converted into TU . From Ohm's Law $I=E/R$. Since $P=EI$ it is also equal to $E(E/R)=E^2/R$. Consequently if the input and output resistances or impedances are equal, $P_1/P_2=E_1^2/E_2^2$. The power ratio is then equal to the square of the voltage ratio. Likewise for current measurements $P=EI=RI^2$ and the power ratio is equal to the square of the current ratio.

As squaring a number multiplies its logarithms by 2 and since $TU=10 \log P_1/P_2$, $TU=20 \log E_1/E_2=20 \log I_1/I_2$. It must be noted, however, that the voltage or current ratios can properly be used as an index of the transmission efficiency of a circuit only then equal to the square root of the ratio of the corresponding powers. This means that the input impedance of the circuit must be equal to its output impedance.

An example of the use of voltage ratios is furnished by a two-stage audio amplifier using 301-A tubes and a $2\frac{1}{2}:1$ transformer. The theoretical ratio of output to input voltage of this tube is 8; associated with a transformer, each tube gives a voltage amplification of $8 \times 2\frac{1}{2}=20$ or $20 \times 20=400$ for the two stages. From the formula, $TU=20 \log 400=20 \times 2.602=52.04 TU$.

If the table is used for figuring voltage or current gain or loss, the number of TU for a given power ratio must be doubled. Or conversely the ratio must be halved to find the number of TU . Thus in figuring the TU gain for an amplification of 400, using the table and its accompanying rules for ratios greater than 10, proceed by dividing the ratio by 10 and adding 10 to the number of TU . Performed consecutively this gives 40 and +10, and 4 and +20. A power ratio of 4 is equivalent to 6 TU ; $6+20=26 TU$, doubling gives 52 TU , which checks with the more exact method given above.

A change of 1 TU is just perceptible to the normal ear, but a difference of 10 TU in the highest and lowest notes do not make a very great difference in quality of tone reproduction. Any amplifier or loudspeaker which does not differentiate more than 10 TU between the various notes is passably good in the present state of art.

Tell them that you saw it in RADIO

New AERO Circuits

For Either Battery or A. C. Operation

The Improved Aero-Dyne 6, and the Aero 7—Popular new circuits—are built around these marvelous coils.

You Should Learn About Them Now!

Proper constants for A. C. operation of the improved Aero-Dyne 6 and the Aero Seven have been studied out, and these excellent circuits are now adaptable to either A. C. or battery operation. A. C. blue prints are packed in foundation units. They may also be obtained by sending 25c for each direct to the factory.



AERO UNIVERSAL TUNED RADIO FREQUENCY KIT

Especially designed for the Improved Aero-Dyne 6. Kit consists of 4 twice-matched units. Adaptable to 201-A, 199, 112, and the new 240 and A. C. Tubes. Tuning range below 200 to above 550 meters.

This kit will make any circuit better in selectivity, tone and range. Will eliminate losses and give the greatest receiving efficiency.

Code No. U-16 (for .0005 Cond.)...\$15.00
Code No. U-163 (for .00035 Cond.)...\$15.00



AERO SEVEN TUNED RADIO FREQUENCY KIT

Especially designed for the Aero 7. Kit consists of 3 twice-matched units. Coils are wound on Bakelite skeleton forms, assuring a 95% air dielectric. Tuning range from below 200 to above 550 meters. Adaptable to 201-A, 199, 112 and the new 240 and A. C. tubes.

Code No. U-12 (for .0005 Cond.)...\$12.00
Code No. U-123 (for .00035 Cond.)...\$12.00

NOTE: All AERO Universal Kits for use in tuned radio frequency circuits have packed in each coil with a fixed primary, a twice-matched calibration slip showing the reading of each fixed primary AERO Universal Coil at 250 and 500 meters; all having an accurate and similar calibration. Be sure to keep these slips. They're valuable if you decide to add another R.F. Stage to your set.

A NEW SERVICE

We have arranged to furnish the home set-builder with complete Foundation Units for the above named circuits, drilled and engraved on Westinghouse Micarta. Detailed blue-prints for both battery and A. C. operation and wiring diagram for each circuit included with every foundation unit free. Write for information and prices.

♫ ♫

You should be able to get any of the above Aero Coils and parts from your dealer. If he should be out of stock order direct from the factory.

♫ ♫

AERO PRODUCTS, INC.

Dept. 103

1772 Wilson Ave.

Chicago, Ill.

(Continued from page 25)

stations to stop sending, so the air will be clear for handling the messages about the ship in distress. They have to shut down or lose their licenses. They can't open up again until one or two ships at least are on their way to help the one that is in trouble and the one in trouble is notified that help is coming. Then the district communication superintendent gives the broadcasters the air again."

"How much would it cost us to get you to take a little trip out to sea Monday, and send an SOS just to see how it works—be liberal with yourself." Casey with raised brows, waited for Abie's answer.

"I couldn't do it—I got an engagement for Monday night," said Abie.

"You could go outside the twelve-mile limit—you could get away easy," said Casey.

"Not unless I was on a rum smuggler," declared Abie. "As close as that the revenue cutters might come to the rescue and I'd have to sink the boat or go to jail. I wouldn't want to sink a perfectly good boat, Mr. Casey, even if it wasn't mine."

Mr. Casey thought deeply. "Could an SOS be sent on land?" he asked.

"Why not?" said Abie.

"Could you set up and operate a sending station?"

"Sure!"

"Will you?"

"I'll set it up. Installing radios is my business. I'll set you up a station and you can work it yourself."

"H'm," mused Casey. "Could I learn the trade by Monday?"

"Look here how easy it is, Mr Casey." Abie made three dots, three dashes and three more dots on a piece of paper with a pencil. "Take the end of the pencil in your fingers, Mr. Casey, the sharpened end. Now press down so the end of the lead hits the desk and the rubber end goes up in the air. Now let it up. Every time you tap the lead on the desk like that it's a dot; hold it down half a second and it's a dash. A radio key works like that, only easier. Now make three dots, three dashes and three more dots—that's SOS."

"And they pay radio operators a hundred dollars a month and board for doin' that?" asked Casey.

"Of course there's more things to learn if you are going to make a living at it, Mr. Casey. You have to know how much you can charge the customers and get away with it."

"How long will it take you to install the apparatus?" asked Casey.

"Where? Here? Not over three hours," Abie answered.

"Do it now—we'll watch you," said Casey.

Abie's car was back in half an hour. He came up the steps with cartons piled

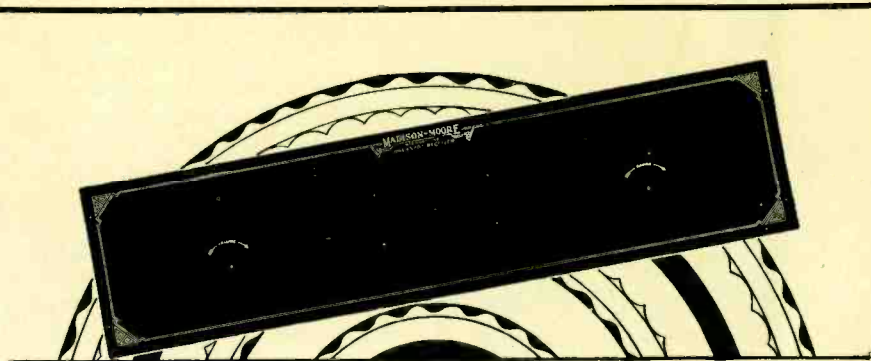

New Formica Kit Panels

RECENT additions to the list of handsomely decorated panels for famous kits include the Madison Moore International One Spot (A. C.) E. T. Flewellings Super Eight, and the new B*T Power Six Electric Kit. There are also front and sub panels for Karas (two dial), World's Record Super Ten; Camfield Nine; Tyrman; Magnaformer, H. F. L. Victoreen and many others.

These panels are sold by all leading jobbers

The FORMICA INSULATION COMPANY
4618 SPRING GROVE AVENUE CINCINNATI, OHIO

Any jobber or dealer can get Formica panels for you

FORMICA
Made from Anhydrous Bakelite Resins
SHEETS TUBES RODS

Formica has a Complete Insulating Service for Manufacturers.

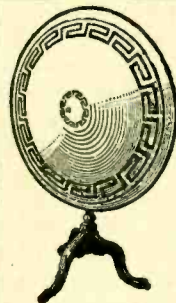

The New POWERTONE 36" GIANT Cone Speaker Kit (Double Edge)

A speaker of beauty, tone quality and has the characteristics of the higher priced speakers. Can be assembled in less than an hour.

The POWERTONE kit consists of:

- | | |
|------------------------|--------------------|
| 1 POWERTONE UNIT | 1 Apex |
| 1 Designed Front Sheet | 1 Tube Cement |
| 1 Fonotex Paper | 1 Set Screws, Nuts |
| 1 Back Sheet Paper | 1 Stand |
| 2 Metal Rings | Full Instructions |
| 1 Metal Bracket | |

\$12.00

Incl. Stand FREE

Powertone Cone Unit \$5.50

Dealers and Jobbers Write for Proposition

POWERTONE ELECTRIC CO.

218 FULTON ST., N. Y. C.



How will you spend your Christmas gift money?

What could be more useful, and at the same time give greater enjoyment to the entire family, than something truly needed for the radio?

Your radio is the heart of the home. Then keep it in best condition, for a longer radio set life with a Weston Radio Instrument.

Scores of thousands are now operating their sets more economically and with better reception by means of "Westons." Your dealer will help you select the model you need—

The Pin-Jack voltmeter for Radiola, Brunswick and Victor sets; the D.C. or A.C. portable model for general testing, shown below, and panel types for professional or home-built sets. All at attractively low prices.

It will pay you to write for Circular J—a useful guide to instrument selection and set testing. Weston Electrical Instrument Corp., 156 Weston Ave., Newark, N. J. Or write to:

Pacific Coast Representatives

Graybar Electric Company, Inc.
84 Marion St., Seattle, Wash.
J. H. Southard, San Francisco, Calif.
A. A. Barbera, Los Angeles, Calif.
Repair Service Laboratory
682 Mission St., San Francisco, Calif.

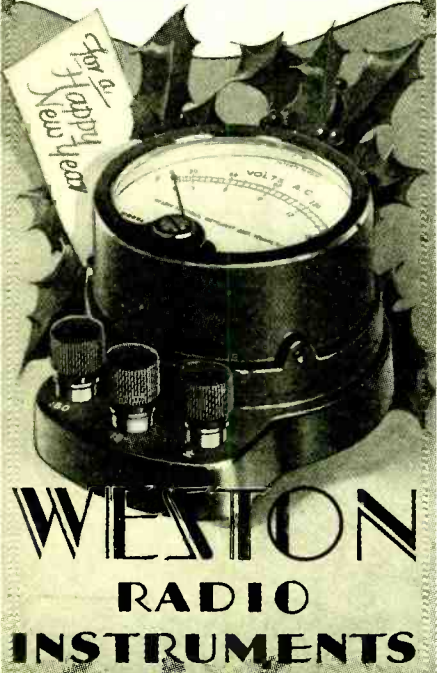

high in his arms. In fifteen minutes he had the apparatus arranged on the table. There was a box with two uprights on the cover and these uprights held two short metal rods with their ends an inch apart. Also there was a telegraph key, some condensers and batteries, and coils of wire.

"Do you want it installed permanent, or just hooked up so it will work a little while, Mr. Casey?" Abie asked.

"If it lasts an hour it's enough," Casey answered. Abie did not bother to screw the apparatus down.

When he came down from the roof, where he had gone to string the aerial, Abie announced that the transmitter was ready.

"What wavelength is it?" asked Casey.

"If there is any wavelength it won't cover I'll give your money back," declared Abie.

"How do you adjust it?"

"There's nothing to adjust, Mr. Casey—just press the key and it covers every wavelength at once."

"Abie, you're a smart boy," said Mr. Casey. "If I had had your advantages when I was a boy I would be president by now."

"Education is a great thing, Mr. Casey."

"Could I try this now?" asked Casey.

"Just a minute, till I disconnect the aerial," Abie answered. "You're supposed to have a license for a transmitting station—I'll disconnect the aerial, then there won't be any trouble."

The wire disconnected, he invited Mr. Casey to try his fist. Minelli and Goldberg closed in on the apparatus to see what happened.

Casey touched the key. A spitting flame flashed between the points of the bars on top of the little box. Minelli went up in the air and landed in the wastebasket.

"Sacre mon dieu!" he yelled. "I'm electrocuted!"

Abie extricated him from the rubbish. "You should not lean with your hands on the high tension wires, Mr. Minelli," he said.

Mr. Casey was making dots and dashes like a child with a new toy. "Do you think they will hear it, down at that place where the what-do-you-call-him sends out the orders for the broadcasting stations to shut down?" he asked.

"Mr. Casey," replied Abie impressively, "I'll give you a thousand dollars for the campaign fund if it don't knock him out of his chair."

"O. K. What's your bill?" asked Casey, taking out a check book.

Abie made some figures on a box cover and winked at Goldberg when the others were busy examining the apparatus.

"For the party, I will put it in for \$500, Mr. Casey," he answered presently. "I wouldn't ask you for all cash

ACME



Flexible Celatsite Wire

A cable of fine, tinned copper wires with non-inflammable Celatsite insulation. Ideal for sub-panel or point-to-point wiring. Strips easily, solders readily. Nine beautiful colors; sold only in 25 ft. coils, in cartons colored to match contents.

Acme Celatsite Wire

Tinned copper bus bar hook-up wire with non-inflammable Celatsite insulation, in 9 beautiful colors. Strips easily, solders readily, won't crack at bends. Sizes 14, 16, 18, 19; 30 inch lengths.



Spaghetti Tubing

Oil, moisture, acid proof; highly dielectric—used by leading engineers. Nine colors, for wire sizes 12 to 18; 30 inch lengths. (We also make tinned bus bar, round and square, in 2 and 2½ ft. lengths.)

Stranded Enameled Antenna

Best outdoor antenna you can buy. Seven strands of enameled copper wire. Presents maximum surface for reception, resists corrosion: this greatly improves the signal. Outside diameters equal to sizes 14 and 16. (We also offer solid and stranded bare, and stranded tinned antenna.)



Loop Antenna Wire

Sixty strands of No. 38 bare copper wire for flexibility, 5 strands of No. 36 phosphor bronze to prevent stretching. Green or brown silk covering; best loop wire possible to make.

Battery Cable

A rayon-covered cable of 5, 6, 7, 8 or 9 vari-colored Flexible Celatsite wires for connecting

batteries or eliminator to set. Plainly tabbed; easy to connect. Gives set an orderly appearance.



Send for folder
THE ACME WIRE CO., Dept. R
New Haven, Conn.

ACME WIRE

MAKES BETTER RADIO

money only if you didn't have a license and if anything should happen, the government would take the outfit."

"After Monday midnight the government can have the outfit for all I care," replied Casey, starting to write a check.

"Have you got a good receiver to hear all the stations about the election?" asked Abie. "With a superheterodyne you could bring in any station in the country. I can give you the best receiver in the world, if you don't want gold trimmings and stuff like that that don't make it work any better, for five hundred dollars. No outside wires, no batteries, just plug it into a light socket anywhere."

"Bring it down," said Casey. "It will be nice to entertain the boys with while they are waiting for us to deal out the jobs on Wednesday morning."

On Monday evening Casey, Minelli and Goldberg sat once more in the private office at campaign headquarters. The loud speaker of the superheterodyne was rolling out in thunderous tones the message that was to turn the tide of the election. The grand coup was reserved for the closing sentences.

"We do not wish to embarrass our opponents by a premature announcement, but inasmuch as they cannot, in fairness to their constituents, avoid making the announcement, before the polls open in the morning, that their candidate for governor has been discovered to be ineligible to fill the high office to which he aspired, even if he should be elected, which he could not be, we may as well make that fact known to our loyal constituents who have beaten the opposition to a standstill and who will all share in the glorious victory at the polls."

"It is a model of forensic oratory," said Casey. "If you have ever kicked over an anthill, Goldberg, you can imagine what is now going on at the headquarters of the opposition."

He removed an oilcloth cover from the radio transmitter that Abie had installed. "The moment has come," he said. "By the time they get to the microphones to deny that, they might as well try to talk through the Chinese wall."

HE PRESSED THE KEY, MAKING THE DOTS AND DASHES OF THE SOS. "It is the message that has summoned help for many another ship in distress," he said, "may it save the ship of state!"

The high tension wires transferred a liberal portion of their energy to the receiving set, by induction, and the loud speaker cone almost split with the thunder of the call. Casey repeated it again and again, gloating over the power he was wielding.

At last he stopped, and listened to the broadcast again. He heard a call like an echo of the one he had just sent. It was accompanied by other code signals that he did not understand.

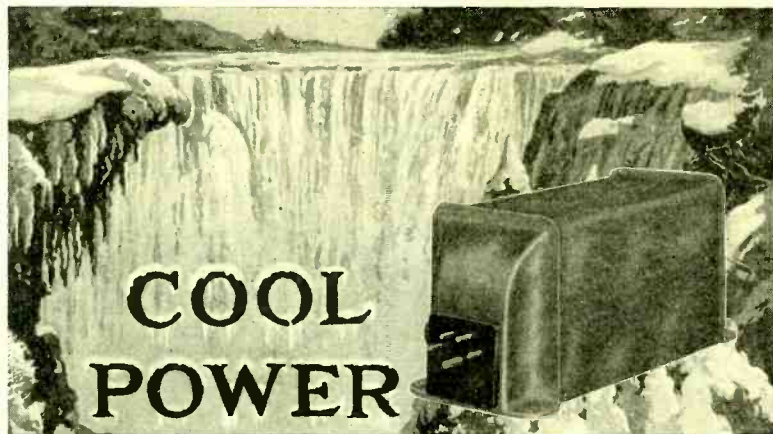

Samson Power Block No. 210—The only block which will supply 500 volts at 80 mils to two 210 tubes.

Powerize with Samson Units for Best Results

For new SAMSON Power Units insure the best there is in radio current supply by

1. Doing away with hum, motor boating and poor voltage regulation.
2. Remaining so cool after 24 hours continuous operation under full load that they will be well within the 20° rise of temperature specified by the A.I.E.E.
3. Being designed to more than meet the specifications adopted by the National Board of Fire Underwriters.
4. Insuring safety against shock because of protected input and output terminals.
5. Insuring for all tubes the correct filament voltages specified by their manufacturers.
6. Compensating for lighting circuit voltage variation by the use of a specified input plug and terminal block to which is attached a 6 ft. flexible rubber-covered connecting cord and plug.

Our Power Units bulletin descriptive of these is free for the asking. In addition, our construction bulletin on many different "B" Eliminators and Power Amplifiers will be sent upon receipt of 10c. in stamps to cover the mailing cost.

Our book—"Audio Amplification"—accepted as a manual of audio design by many radio engineers—contains much original information of greatest practical value to those interested in bettering the quality of their reproduction. Every radio enthusiast should have a copy.

Samson Electric Co.

Manufacturers
Since 1882



Main Offices at
Canton, Mass.

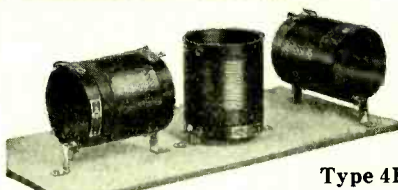

Type 4D

The New Diamond Cut PRECISION COILS

are now the
"Standard of Comparison"

They are accurate to within 1% of the rated inductance and most of them are better. Only with diamonds can this extreme accuracy be obtained. The diamond cut bakelite assures accurate spacing of the turns and uniform diameter of the tubing. Our new catalogue gives more details. Send for it.

Coils shown are our Type 4D
and R. F. Choke No. 420.
Type 4D—\$5 No. 420—\$1

PRECISION COIL CO., Inc.
209 Center Street, New York City



Check Your Condensers

Compactness, simplicity and dependability are the new quality standards for better set construction. Sprague Midgets, small, compact and dependable meet every set building requirement.

Order the new .1 M.F.D. from your dealer or send one dollar for sample complete with mounting bushings. It is the outstanding condenser revelation of the season.

SPRAGUE SPECIALTIES CO.

Dept. R
Quincy, Mass.

SPRAGUE

Tell them that you saw it in RADIO

Oh Man!— Look What's Here

*Doubles Your
Distance*

*Doubles
Selectivity on
Local
Stations*



Sargent-Rayment Station Isolator

The Station Isolator is designed to operate with any set using an antenna and a six volt "A" battery and also with the Crosley AC Bandbox and Radiola 16 and 17. It is a powerful stage of radio frequency amplification that goes ahead of the receiving set, greatly increasing the power of the set and improving its selectivity. The Station Isolator is especially recommended for congested broadcasting districts as it will more than double the selectivity of the set on local stations. It absolutely prevents overlapping of locals and will cut through to get distance with all locals on the air.

PRICES

Model "A." For Apex, Crosley Band Box, New Freshman Equaphase and Atwater Kent No. 30, 32 and 35. (No tube required)

\$10.00

Model "T." For all other sets that use an antenna and a 6 volt "A" supply. Requires one CX-301-A tube. If tube is wanted, add \$1.75 to remittance

\$17.50

SOLD ON 5 DAY MONEY-BACK TRIAL

1928 "DX" INFRADYNE

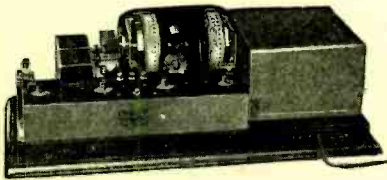

Completely Wired—\$179.50

The Infradyne has proved itself to be the outstanding set of the 1927-28 season. West coast owners are consistently getting New York, Havana and Florida stations. Eastern owners report KGO, KJR and KFI. The five and ten tube switch make it into a set that any member of the family can operate. The Infradyne has razor-edged selectivity, tremendous power, and is the biggest money value in radio. Each set is assembled, wired, carefully balanced and tested in our laboratory before being shipped. Each set is actually tested on DX reception. This personal service guarantees that you will get real Infradyne results.

Model "DX" Infradyne Kit

Complete, including cabinet—\$172.50

Send for our New Catalog, just off the Press

Dealers write

Radio Constructors Corporation

357 TWELFTH STREET

OAKLAND, CALIF.

JENSEN SPEAKER

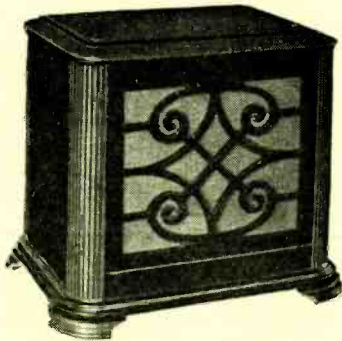

Price **\$65.00**

A Revelation!

Designed by Peter Jensen, pioneer radio designer, this speaker represents another step forward at a time when seemingly the limit in loud speaker perfection had been reached. The Jensen has a clarity of tone hitherto unapproached by anything. It will stand enough volume to fill an auditorium.

Jensen Power Speaker

Built to order, five day delivery. Into the Jensen Speaker we build a complete power amplifier that brings out the full beauty of the Jensen speaker tone. No larger than the original speaker. Everything is in the case. Will out-demonstrate any power speaker made. Price, complete with tubes \$130.00. 25% deposit required with order.

The announcer continued for a few moments his remarks about the next number on the program, but was cut off in the middle of a word. A little later he came back on the air with the brief announcement that all broadcasting stations had been silenced so as not to interfere with the handling of traffic incident to a distress signal.

Casey leaned back in his chair and rubbed his hands gleefully. "Too late for letters, too late to run the thing down and get an explanation into the papers, and the radio not working. Let's see 'em beat that," he said.

"The whole district is looking for me to get them jobs, by now," said Minelli.

"The state should have an official broadcasting station, with Abie in charge," said Goldberg.

Casey passed the cigars, not the kind he gave the voters but the dollar ones reserved to exhale incense in the sacred precincts. Before he had time to light up and say what was on his mind, the telephone rang. The man at the other end was so excited that his loud voice could be heard distinctly by all three as soon as the receiver was lifted.

"It's me boy," said Casey. "Hello, hello!"

"Dad! What in thunder have you been doing?" demanded the young man.

"Who, me? Why I'm just setting around with some other members of the committee listening to the speeches," Casey answered.

"You've got a radio transmitter there at the office!"

"Now how did you guess that, Dinnie?"

"Guess! Ye gods, Dad, do you think anybody has to guess when a rock crusher like that opens up! You haven't even got a helix—you're working with a spark gap right in the aerial circuit—I heard you!"

"What do you mean a rock crusher?" asked Casey, winking at his brother politicians.

"Well it ain't what they use where you're going if you don't beat it," replied his son. "In the penitentiary they break stones with a hammer. You've got to beat it, Dad, and if you don't make it snappy—"

"But Dinnie, lad, how would anyone know where a radio sender was, when it don't tell in the newspaper? How do you know it's here? And don't I know every cop on the beat and the sergeants and inspectors and captains and the chief and the judges? Who would there be to arrest me if they did know anything, Dinnie?"

"But Dad, get this!" implored the lad. "It ain't the city cops and judges you're up against. The radio compass men at five Navy compass stations swung their loops on you. I copied the bearings myself on a chart and the lines meet right exactly where your office is.

They've got you spotted. By this time the federal detectives are on the way to get you. You've broken an international law. For heaven's sake, beat it, Dad!"

Casey hung up the receiver after a hasty "All right, my boy." He looked at Minelli and Goldberg and it would be hard to tell which was more scared.

"Abie told you!" said Goldberg.

"Anyhow, Abie sold me," Casey answered. "I told Mrs. Casey when Dinnie first asked for radio parts that the boy should have a chance to develop his talent. I should have asked him."

"Yank that thing apart, put the stuff back in the boxes and bring it along," he ordered a moment later.

He picked up the phone and spoke to the office operator: "Miss Murphy, if anybody asks for us we haven't been here all the evening and you don't know where we are."

"More than that if necessary, Mr. Casey," replied the voice with a smile.

Casey and his colleagues went down the back stairs. At the end of the alley stood a taxi. "Jimmie," he said to the driver, "what ships are sailin' tonight?"

"Where to, Mr. Casey?" asked the chauffeur.

"Anywhere at all, so long as we don't have to have passports," replied Casey. "I don't want to have to pose for my picture just now. Pick one where you know a steward who can take us on board quiet like."

The chauffeur drove them to a pier. A few words with a steward and they were conducted up a gang plank, aboard a ship and into a stateroom. "Did you ever think you would like to drive a fire engine?" Casey asked the taxi driver.

"I'd rather be a building inspector," replied Jimmie.

"It's well to aim high, Jimmie," said Casey, handing him a twenty dollar bill. "I'll speak to the chief. Of course you don't know me, but you'll hear from him."

"No, sir—yes, sir," said Jimmie.

"Do you happen to know the name of this ship?" asked Casey.

"No, sir—you see I take so many passengers to so many ships."

"Good!" said Casey. "Now, if you could find it again without knowing its name or where it is, drive up to my house and get me some clothes and tell the Mrs. not to worry, that I am just going away incognito, as the papers say, to rest up after the hard campaign, and no one is to know anything about me."

"Yes, sir."

"And throw this junk overboard that we brought with us."

"Yes, sir."

TWENTY-FOUR hours out, Casey called at the window of the radio cabin. Goldberg and Minelli were too seasick to leave their berths.

"Is there any news of the election?" he asked the operator.



The Celestial Stradivarius The Advanced Hi-Q Six BOTH CUSTOM-BUILT!

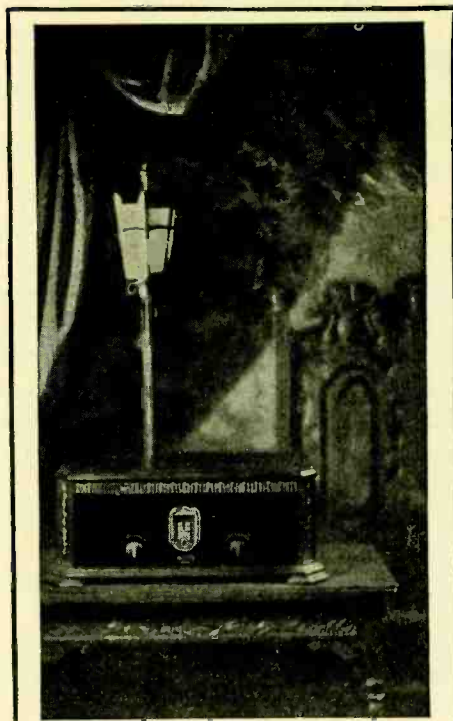

The Hi-Q SIX—the newest advance in radio—four completely isolated tuned stages—Automatic Variable Coupling—symphonic amplification. This non-oscillating, super-sensitive receiver assures maximum and uniform amplification on all wave lengths and establishes a totally new standard of tonal quality.

Hi-Q*: High Ratio of Reactance to Resistance. High ratio—great selectivity—loud signals.

JUST as Antonio Stradivari gave the priceless CUSTOM-BUILT violin to musicians of his day, so does Hammarlund-Roberts offer music lovers of our day the CUSTOM-BUILT Radio—

the advanced "Hi-Q Six" designed by ten of America's leading manufacturers—made with America's finest parts—incorporating every modern constructional feature—and built under your own eyes from plans so complete, so exacting and so clear-cut that the only outcome can be absolute radio perfection.

In addition to its unprecedented performance, the Hi-Q Six offers equally unprecedented economy, for by building it yourself you can save at least \$100.00 over the cost of fine factory-assembled sets. Complete parts, including Foundation Unit of chassis, panels and all wire and special hardware, cost only \$95.80.

The Hi-Q Instruction Book tells the complete story with text, charts, diagrams and photos. Anyone can follow it and build this wonderful instrument. Get a copy from your dealer or write us direct. Price is 25 cents.

**Hammarlund
ROBERTS
Hi-Q SIX**

HAMMARLUND-ROBERTS, INC.
1182-C Broadway New York City

Associate Manufacturers



The next 6
issues of **6**
"RADIO"
for **1** dollar

Subscribe Now



FAST CONDENSERS FOR ABC PACKS

Fast Hi-Test, extra capacity condensers are built to withstand every requirement of usage. Millions now in use and since 1919, one of the oldest established and reliable manufacturers.

An exclusive feature—by-pass condensers enclosed in one-piece die-press steel housing, makes them positively impervious to climatic conditions or abuse. Before being encased condensers receive special laboratory treatment, moisture content is effectually removed and the housing seals them permanently—Fast condensers thus give better service.

Illustration shows condenser pack used in Q. R. S. or Raytheon A-B-C unit. Fast condensers fit all units, whether specified or not. Write for free condenser booklet. Dealers and jobbers, send for prices.

JOHN E. FAST & CO.

3982 Barry Avenue, Dept. C, Chicago, U. S. A.

Tell them that you saw it in RADIO



Are you building
one of these
Power Units

THORDARSON
AMERTRAN
RAYTHEON
SAMSON
Q.R.S.

?

Dubilier Condenser Blocks

for these well-known B and A-B-C power supplies are all that the care-taking experimenter could ask for in ruggedness, accuracy, safety and long life. Dubilier Type PL 574 is designed especially for the Thordarson R 171 Power Compact, and all light socket devices employing the Raytheon BH Rectifying Tube. Maximum transformer voltage should not exceed 700. Type PL 575 block is the approved condenser for Thordarson R 210 Power Compact, Amertran, Samson and all other power supplies using 216 B or 281 type filament rectifiers. Maximum transformer voltage not to exceed 550 Volts per plate. Full instructions enclosed. Your dealer has them. Type PL 574—\$16.50. Type PL 575—\$17.50.

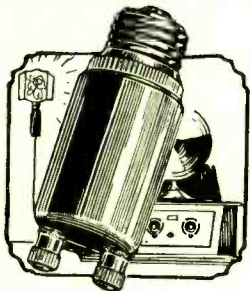

You Can't Build
a Better Aerial

So why bother with a troublesome, expensive outdoor antenna? Just connect the Dubilier Light Socket Aerial to your set and plug in. All the distance you need, all the volume you want, and clarity that an outdoor aerial can't touch. Less static, less interference and no lightning hazard. You risk nothing to prove it, for all good dealers sell the Dubilier Light Socket Aerial with a 5-day money-back guarantee. Price.....

\$150

Dubilier
CONDENSER CORPORATION
4377 Bronx Blvd., New York

The operator took a typewritten sheet from a hook beside the receiver and read:

"Party in power won by fifty per cent more than the normal majority, due to dastardly trick attempted by unknown persons to deceive voters. Prompt work of Navy radio operators and federal detectives in running down fake SOS call enabled broadcasters to get on the air again in time to contradict false statement that candidate for governor was ineligible. Several prominent politicians failed to appear at the polls this morning and cannot be located."

Casey turned away, but was recalled by:

"Wait a minute—here's something more."

The operator, with the phones on his head, copied for a few minutes. Then he read:

"Dennis Casey, son of politician missing since fake SOS call was sent out on eve of election to shut opponents from air, has been arrested. He is known as a radio expert among the amateurs and authorities assume he may know something about the matter."

Casey's jaw set hard. "Will you send a message for me?" he asked.

"Certainly, sir." The operator handed him a blank and a pencil.

In a few minutes Casey handed in his message. It was addressed to the chief of police of the city from which they had sailed. It read:

"Please see that my boy is released at once. He was in no way responsible. I will return on first ship sailing and will answer to any charge brought against me."

LETTERS TO THE EDITOR

(Continued from page 44)

heard of an antenna series condenser making a set tune broadly? The reverse is of course true because it has the effect of shortening the electrical length of the circuit, and why do we have to drag out the old dusty idea that the counterpoise *must* be directly under the antenna? The inductive and capacitive relation between the antenna and counterpoise is so small that it can be taken as identical with the relation of the antenna to earth, so it is between the set and the earth that we are interested and not between the antenna and counterpoise, so what does it matter which side of the house it is on? The biggest worry we have is to get it over as damp ground as possible and keep the weeds from under it, and keep it from swinging in the wind so it will not change the tuning.

Sig. GEORGE T. MOOD, 7BK,
ELMER F. RUDESILL.

4055-42nd Ave., S. W.,
Seattle, Wash.

PAR VOLT

WOUND CONDENSERS

Stand the Surges

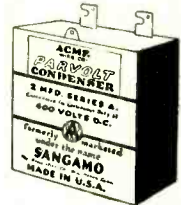

Capacities
and Prices

Series A 400 Volt Duty	Mfds.	Series B 800 Volt Duty
\$.85	.1	\$1.25
.95	.25	1.50
1.00	.5	2.00
1.25	1.0	2.50
2.25	2.0	3.50
4.00	4.0	6.00

We Recommend

Sangamo Mica Condensers



The Acme Wire Co.

New Haven, Connecticut

6131-1

**NOW A-C
OPERATED**

USING STANDARD CUNNINGHAM OR RADIOTRON TUBES
The new 2-Dial Karas A. C. Equamatic uses standard Cunningham or Radiotron tubes. It is a powerful, long-range, sweet-toned receiver with full A. C. operation that will delight you with its superior performance. Send for complete data and full size wiring diagrams.

Affiliated Manufacturers:
Carter Hammarlund Sampson International
Yaxley Benjamin Electrad Resistor Co.
KARAS ELECTRIC CO.
4031-A North Rockwell St. Chicago



Tell them that you saw it in RADIO

THOMSON GALVANOMETER

(Continued from page 26)

such nullification of the earth's force, something will be left, and the mirror will settle into a zero position with rather long swings before settling. If, however, the neutralization should turn out to be rather complete, a permanent magnet placed above the device will affect more strongly the magnets nearest to it, and so will give directional effect enough to bring the mirror to the desired zero.

We have said that the mirror is suspended in the hollow of the coil. This is best accomplished by making the coil in two halves. As to the suspension, it is done by means of a single unspun fibre of silk, which is best worked on a dark cloth and attached by means of a tiny drop—or part of a drop—of shellac. As the coil is stationary and carries the current, there is no need of a conductor attached to the mirror.

Ford automobile magnets may be used for forming the magnetic field of the instrument. They are of good steel with high retentivity, of the right size, and have a sufficient spread at the open end of the horseshoe. Two of them will give a good strength of field at the coil.

The special trick in fitting these magnets to the coil is in inclining them to

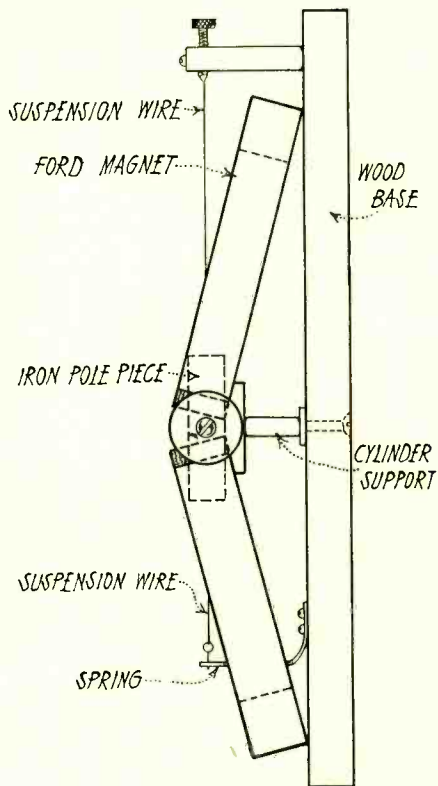

Fig. 2. Fitting Magnet to Coil.

the base as shown in Fig. 2, wherein it is made clear that the curve of the coil lies against the baseboard and the end, or open portion of the magnet, is lifted above that baseboard. The angular relation of magnets and baseboard enables the suspension wires to pass in the clear from the movable coil to their points of

WANTED!

Radio Dealers

PROFESSIONAL

Set Builders and Radio Fans

IN every community to introduce and become our factory Representative on the newest, most revolutionary radio development in the history of the industry... The SUPER HILODYNE Circuit, a radio circuit that is modern and independent. See December issue of Radio News.

The SUPER HILODYNE is a new basic circuit employing nine tubes. Its all around performance will amaze you. You can help repeat Radio History and make money by representing us in your community in your full or spare time. Write TODAY for details. Dept. R-128.

ALGONQUIN ELECTRIC CO., Inc.

245 Fifth Ave.

New York City

RADIO Agents Wanted

Make Big Money in Spare Time

Demonstrating the Famous Trego Radios and Phonographs to your friends. Made in both Five and Six-tube Tuned Radio Frequency Sets, at prices ranging from \$49.50 to \$173.80; also the last word in Portable Phonographs; ideal for home, motor trips, camps, etc. \$15 and \$25. As well as hundreds of other fast selling articles for agents

DEPT. NO. 1

TREGO RADIO MFG. CO.
1427 Chestnut, Kansas City, Mo.

\$1.00 WILL SAVE YOUR SPEAKER



The Craftsman Dollar Speaker Filter is Guaranteed to relieve your speaker of the D. C. plate current (up to 250 volts). It gives speaker a chance to operate at its best. Attached in a second. Send dollar bill NOW!

CRAFTSMAN RADIO PRODUCTS
9 Orchard St. Newark, N. J.

Subscribe Now To
"RADIO"
\$1.00 for six months

SELL YOUR EXCESS PARTS
Through a Classified Ad in
"RADIO" See Page 79

Tell them that you saw it in RADIO

No OPEN CIRCUITS
with the
New



*all
duty*

DAVOHM

After months of research, Daven, the Resistor Specialists, are giving to the Radio Fans of America what they honestly believe to be the most perfect wire wound resistor. . . Davohm.

Will Not Open Circuit

Davohms are built to the most exacting specifications. The enamel is a special composition which resists the highest temperatures. Davohms will not open circuit. Davohms will carry their full rated current capacity plus an overload, safely without excessive heat.

Constant Efficiency

Davohms are accurately rated when you buy them and they remain accurate. If you draw 125 milliamps from a Davohm, it will continue to deliver 125 milliamps indefinitely. No other resistor that we know of will give the same unchanging efficiency as Davohm.

For All Power Packs, A, B and C Eliminators using 171 or 210 Tubes

Davohms are made in 4 sizes in values from 500 to 25,000 ohms and for all current carrying requirements, dissipating all wattages specified in power packs and eliminators using 171 or 210 tubes. The Resisto-Prop, an exclusive Daven product, makes mounting a simple matter.

At your dealer

Daven Radio Corporation
135 SUMMIT ST. NEWARK, N. J.



FREE!
30 DAY TRIAL!

Powerful 6-7 or 8 Tube Guaranteed RADIO

Radio's most amazing bargains, direct from big, reliable maker (8th successful year). All Electric or Battery sets. Consoles or table cabinets. Don't buy unless 30 days trial period. Miraco unbeatable at 2 to 4 times the price for selectivity, distance, volume and rich, Cathedral tone. Turn 1 dial for all stations. Completely assembled, fully guaranteed set!

Free literature, users' testimony and BIG SPECIAL OFFER!

MIDWEST RADIO CORPORATION
Pioneer Builders of Sets
414 - D Miraco Bldg., Cincinnati, O.

RETAIL \$36.75 to \$69.75

BIG DISCOUNTS to User Agents

support, which points of support are the terminals of the instrument, electrically. As in the case of the galvanometer described in an earlier story, the suspension wires are of hard drawn silver, secured by drawing the wire oneself—the best way—or having a jeweler do the work. These two silver wires end respectively in a revolable stud at the top and in a rather flexible spring at the bottom. The stud at the top should be so disposed, as shown in Fig. 1, that it can be lowered from the operating position, in which the coil just clears the iron core all around, to a position wherein the coil rests on the top of the core, held there with a little force of the spring at the bottom. In this position the whole device can be transported with the minimum fear of breaking the silver wires.

The core may be either a solid cylinder of iron or mild steel or a section of iron tubing, such as a piece of gas pipe or water pipe. It will be serviceable if

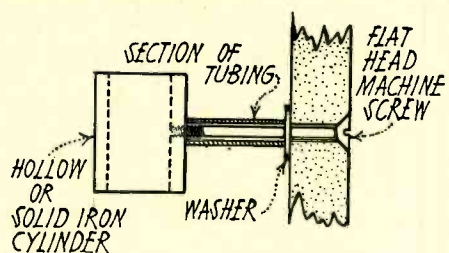

Fig. 3. Method of Holding Coil in Place.

its walls are as thin as iron pipe comes in the market.

The iron core may be easily held in its proper position by means of a single screw and a bit of tubing surrounding the screw, as shown in Fig. 3. A washer at the base of the section of tubing around the screw gives it a good footing against the wood of the base, and prevents its being imbedded too much in that wood.

The movable coil of this type of galvanometer is to be made in the same manner as that described in the earlier story of the instrument in which the magnets stood in position like the letter U. That is, the wire is to be wound on a paraffined cardboard form, heavily shellacked as wound, and then dried in an oven, the latter perhaps improvised from an incandescent lamp and a wooden box. When the alcohol of the shellac has all been dried out, the coil is allowed to cool and will then be found to be a hard, firm, integral thing. In this winding and drying process the ends should be carefully watched so that they may be available at the right time for soldering to the pins that receive the silver wires. They will be very hard to get at if they are allowed to become baked in with the rest of the winding.

The two iron polepieces shown in Fig. 1, adjacent to the movable coil, may be either of cast or wrought iron or of mild steel. Usually the easiest way is to make

Micrometric CONTROL for Your Set

The Volume Control Clarostat now makes its bow. It's a little fellow, compact, good looking, inexpensive, handy—just the thing for applying adjustable yet positive resistance in various parts of the set. And it's a genuine CLAROSTAT through and through.

CONTROL

loud speaker volume; match transformers for best tone quality; tune loud speaker to your taste; get maximum sensitivity out of r.f. and detector tubes; control regeneration micrometrically, especially on short waves—all with Volume Control Clarostat. And there are many other ways now becoming popular for improving your set with micrometric resistance control.

VOLUME CONTROL CLAROSTAT



has resistance range of practically zero to 500,000 ohms in several turns of knob. Ample current-carrying capacity for all receiver applications. Holds its resistance adjustment. Silent in operation. Screw terminals. One hole mounting. And only \$1.50.

Of course you must continue to use the larger Standard Clarostat for B-eliminator applications, and the giant Power Clarostat for A-B-C power units, line voltage control, and power amplifiers, as heretofore.

There's a Clarostat for every purpose. Make sure, however, you get a genuine Clarostat—look for distinctive green box and name CLAROSTAT stamped on nickel shell. Don't be fooled!

Ask your dealer for literature on Clarostats and how to improve your radio set. Or write us direct:

American Mechanical Laboratories, Inc.
Specialists in Variable Resistors
285 North 6th St., Brooklyn, N. Y.



them of cast iron. The procedure in such a case is to make a block of wood of the desired form to fit the Ford magnets, take it to the foundry and have two such pieces cast. Tell the foundryman that you want them cast of soft gray iron. This material is easier to work than other forms of metal, as you will appreciate when you come to file it to exact shape, if that is needed, and still more when you drill and tap the hole that receives the attaching machine screw.

The dimensions of the two gray iron polepieces are fixed by two precedent conditions: the size of the Ford magnets, which are standard, and the size of the movable coil, which in turn may depend on the size of the iron pipe. Whatever these facts are, the polepieces and the core should approach the coil within about 1/64th in. on both sides. However, the sensitivity of the device will not be greatly lessened if the clearance be greater because the lines of force all thread the coil closely whatever the clearance. A satisfactory material for the baseboard is birch.

WHAT NEXT?

(Continued from page 35)

Now, in Washington, the international conference is considering still *another* call of distress. It is to be the spoken word "Mayday," to be used by broadcasting stations. It also will take the place of the familiar SOS that has endured for so many years. "Mayday" is the phonetic spelling of the French words, "M'aider," meaning "help," or "aid me."

With CQD rightfully having been discarded for the SOS by men who had pounded brass themselves, we are to have "Pan" for aircraft and "Mayday" for broadcasting and telephone stations, and—What next?

If such nonsense keeps up each country will soon have its own particular signal of distress; each race; each church; each steamship company; each automobile manufacturer, perhaps each garden gate and tablespoon, until an embryo operator will be obliged to spend ten years learning them all before he can get a ticket.

Radio engineers of the General Electric Co. have designed a reliable system of radio communication between the front and rear ends of long freight trains. A 50-watt phone transmitter is used on the 2300 to 2750 k.c. band. Power is furnished by a motor generator set in the locomotive cab. Simplex operation is employed.

SEND FOR FREE CATALOG
From Chicago's Oldest Radio Jobbers. The Most Valuable Radio Catalog.
 Write for your copy today — IT'S FREE!
Telephone Maintenance Company
 123-5 S. Wells St., Dept. 57, Chicago, Ill.



A Quality Instrument

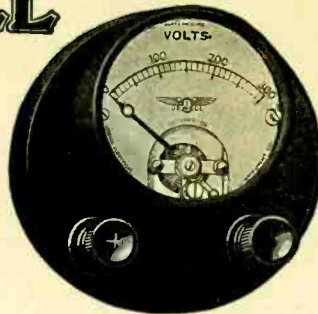

Pattern No. 139
 B-eliminator
 Voltmeter

High Resistance Voltmeter

(For the Set Owner)

You are now able to obtain a high resistance voltmeter to check the voltages of your B-eliminator and at a price that is well within the limits of your pocket book.

The Jewell Pattern No. 139 B-eliminator voltmeter was produced with the set owner's requirements in mind. It is three inches in diameter and of the same permanent magnet, moving coil, D'Arsonval type movement, as are the larger types of high resistance meter. Its 0-300 volt scale enables readings to be taken of all ordinary eliminator voltages. The resistance is sufficient to guard against lowering of the circuit voltage when using the instrument.

Ask your dealer to show you this instrument or write us direct for descriptive circular No. 1103

Jewell Electrical Instrument Company

1650 WALNUT STREET, CHICAGO

"27 Years Making Good Instruments"

Why CeCo Tubes Last Longer



CeCo Tubes are evacuated by an exclusive process developed by our engineers and the exceedingly high vacuum thus obtained is one important reason for the longer life of CeCo Tubes.

Thorough inspection of materials and parts, critical testing to highest standards assures uniform quality, steady performance, longer life.

There's a CeCo Tube for every radio need.

Ask your Radio Dealer for Complete CeCo Data Sheet

C. E. MFG. CO., Inc. PROVIDENCE, R. I., U. S. A.

CeCo
RADIO TUBES

Exclusive Method of
 Evacuating CeCo Tubes

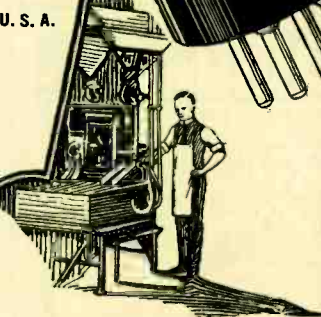

Tell them that you saw it in RADIO



VARIO DENSER

Tune quickly—adjust accurately—eliminate distracting noises—get correct tube oscillation—with X-L VARIO DENSERS in our circuit. Designers of all latest and best circuits specify and endorse them.
MODEL "N"—Micrometer adjustment easily made, assures exact oscillation control in all tuned radio frequency circuits. Neutrodyne, Roberts two tube, Browning-Drake, Silver's Knock-out. Capacity range 1.8 to 20 micro-microfarads. Price \$1.00

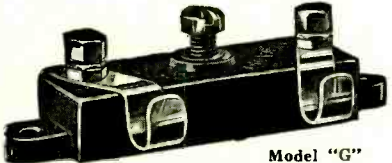

MODEL "G"—Obtains the proper grid capacity on Cockaday circuits, filter and intermediate frequency tuning in superheterodyne and positive grid bias in all sets.
 Capacity range:
 Model G-1 .00002 to .0001 M. F. D.
 Model G-5 .0001 to .0005 M. F. D.
 Model G-10 .0003 to .001 M. F. D.
 Price, each with grid clips \$1.50

X-L PUSH POST—NEW!
 Bakelite Insulated. Push it down with your thumb, insert wire, remove pressure and wire is firmly held. Vibrations will not loosen. Releases instantly. A push post that excels in appearance, action, service and convenience.
 Price each 15c
X-L PUSH POST PANEL—Seven push posts mounted on black insulating panel with permanent white markings. Soldering lugs, raising bushings and screws for mounting, etc., in box complete.
 Price \$1.50



FREE—New, up-to-date book of wiring diagrams showing use of X-L units in the new LOFTIN-WHITE constant coupled radio frequency circuit, and in other popular hook-ups, also the Goodwin Aperiodic Detector Circuit which adds a stage without added tuning controls. Applicable to any set. WRITE TODAY!

XL Radio Laboratories
 2428 Lincoln Ave. Chicago, Ill.

NEXT MONTH
 Best's New Super for A. C. Operation
 Don't Miss February "RADIO"

RADIO WHOLESALE
 Write for my Big 1928 Radio Catalog—just off the press. Thousands of marvelous bargains in nationally advertised goods. All the LATEST IN RADIOS and equipment. Lowest wholesale prices.
FREE Log and Call Book and Catalog. Get your copy today. Send postcard now!
 American Auto & Radio Mfg. Co.
 HARRY SCHWARTZBERG, PRES.
 Dept. 143 American Radio Bldg., Kansas City, Mo. 3

DEALERS NEW 1928 CATALOG Agents Wanted.

RADIO PROSPECTING
 (Continued from page 38)

if the secondary conductor be at some distance from the primary conductor, and furthermore, even if the secondary conductor not be tuned to the frequency of the primary field, under certain limiting conditions. The facts connected with causing the secondary field to extend to considerable distances and measurable intensities constitutes the phenomenon upon which this process is based, and which is not generally known, even to those well versed in high frequency electrical principles.

The mere creation of an intense secondary field is in itself of no value unless a means be developed of utilizing this secondary field to indicate its axis, which lies within the secondary conductor. (If the axis may be located, then the secondary conductor is located.) Here, a principle was borrowed from the radio world, and well-known therein in its particular application, was applied to this more complex problem of locating a secondary field within a primary field. The principle is that connected with the art of radio direction finding wherein a direction finding coil is employed to indicate the direction towards the radio transmitting station.

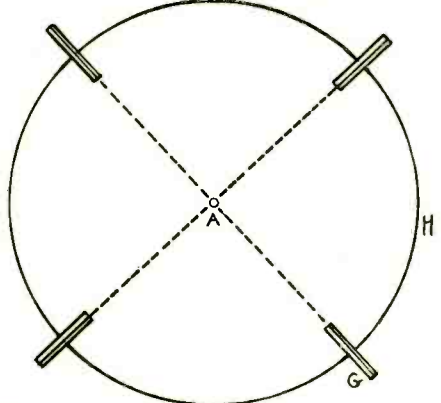

Fig. 10. Principle of Direction Finding Coil.

In Fig. 10 there is represented in plan view, the axis of a primary conductor standing vertically at A, about which there exists a primary electromagnetic field, the magnetic lines of force of which may be represented as the general shape and position of the circular lines H. If a direction finding coil be placed anywhere within the effective area of this field and there rotated about its vertical axis, it will indicate by its position of maximum signal intensity, a direction towards the axis of the primary field such as shown at G. If two or more such directions be obtained and plotted to an intersection, the location of the axis of the primary field will be determined. This is the principle connected with the use of a coil for direction finding, when in the presence of a single electromagnetic field.

In this method and process of locating ore and mines, the basic principle of

Tell them that you saw it in RADIO

Buy An ELECTRIC RADIO

Don't be confused by electrified or other "ied" specials.

Freshman EQUAPHASE

IS THE **ELECTRIC RADIO**

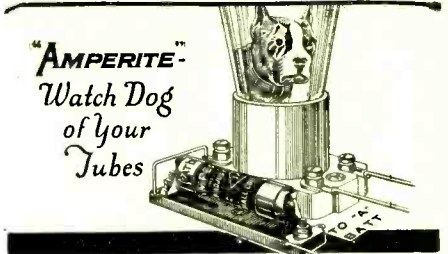

Simplifies—

1. Tube control—No knobs
2. Wiring—Short leads
3. Panel design—No drilling
4. Tuning—No hand rheostats

Only AMPERITE can automatically keep the temperature or voltage of the filament constant despite variations in "A" battery voltage. Particularly essential with eliminators. Proved for 6 years to be indispensable in every radio circuit. Do not confuse with fixed filament resistors. Accept only AMPERITE. Price \$1.10 with mounting (in U.S.A.). At all dealers.

Write for Free "Amperite Book" of season's best circuits and latest construction data. Address Dept. K 1.

Radiall Co., 50 Franklin St., New York
AMPERITE
 The "SELF-ADJUSTING" Rheostat

ORDER YOUR BLUEPRINTS NOW
 for the new 1928 G. M. Best Super
 \$1.00 Per Set, Postpaid
 "RADIO," San Francisco

Your Aerial Deserves

THE ELECTRAD CERTIFIED LEAD-IN



No matter how fine an aerial you have, it cannot give best results without an efficient Lead-In.

The Electrad Certified Lead-In is built to the highest standards of quality. Made of copper, heavily tinned to prevent corrosion, with 10 - inch three - ply waterproofed insulation. Bends any shape to fit under locked doors or windows. Play safe and get the Electrad Lead-In. 40c each.

Write for descriptive circular
At your dealers, or write
Dept. 56B, 175 Varick St., New York

ELECTRAD

Things Don't Just Happen

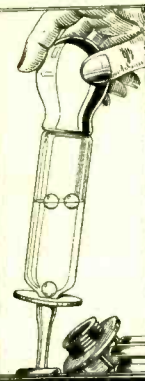

That nothing to equal the patented Chaslyn Balls for accuracy, unbreakability and simplicity of reading has been discovered is why the big manufacturers of Batteries use them as Charge Indicators in Glass-Cased Batteries and Power Units.

Easiest to Read
Nothing to Break

Swim all three—charged fully
Sinks the white—charge still right
Sinks the green—charge is lean
Sinks the red—charge is dead

Ask your dealer. If he can't supply, send 75c to us.

Chaslyn Corrosion Cure for Battery Terminals protects contacts. A large tube is 30c.

THE CHASLYN COMPANY
4629 Ravenswood Ave. Chicago, Ill.

FREE Wholesale Radio Catalog

Dealer-Set Builders! Save Money!

Send for this book of bargains. Everything in Radio—all the newest hook-ups, Sets, kits, parts, cabinets, consoles and supplies. If you want the best for the least money, you need this catalog

SHURE RADIO COMPANY
343 V. West Madison St., Chicago, Ill.

1928 WHOLESALE RADIO CATALOG

R. E. L.

YOU CAN GET QUICK SHIPMENT on all standard parts and kits including latest

L. R. 4. — STROBODYNE — HiQ-6

Send for R.E.L. Handbook and discount list

R. E. LACAUT
Radio Electric Laboratories
1931 BROADWAY, NEW YORK

the direction finding coil is employed in locating the axis of a secondary field, but the action of the coil becomes more complicated because if the coil be placed within the effective area of the secondary field, it will, of course, also be within the effective area of the primary field and as a consequence, the direction finding coil will be acted upon simultaneously by two fields of identical frequency, whose axes do not coincide. This is an unusual application of the direction finding coil and it requires considerable study and work to determine just what sort of direction the coil would give under such a condition, and what the determining factors are for obtaining directions by means of which the secondary axis may be located. This study is an interesting problem in itself but leads into such highly technical subjects as time and space phase difference of electromagnetic fields, time phase relation of component coil current, resultant coil current, polarization of component fields, and of resultant fields, etc.

The elementary principles governing the action of the coil when in the presence of two or more electromagnetic fields of identical frequency are, however, easy to grasp. Referring again to Fig. 10, if in any location such as *G*, the direction finding coil be rotated about a horizontal axis the loudest signal will be obtained when the coil reaches a vertical position. In other words, the direction finding coil, when thus rotated about its horizontal axis, will normally indicate a vertical direction. Now, re-

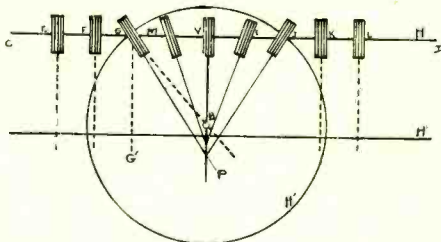

Fig. 11. Profile View of Direction Finder.

ferring to Fig. 11, there is represented a profile view of the cross section of a secondary conductor *B* in a primary field *HH*. The primary field *HH* has caused a current to flow in the secondary conductor *B* and as a result, there occurs the secondary field *H₁*. Suppose now that the coil was operated at various points along the line *CD* by revolving it about the horizontal axis. At points outside of the area of the secondary field *H*, the coil would indicate a vertical direction as at *E*, *F*, *K* and *L*. At *G*, *M*, *V*, *I* and *J*, the coil would be acted upon by both the primary field *H* and the secondary field *H₁*. At any one of these locations, as for instance, at *G*, the primary field would tend to cause the coil to indicate a vertical direction along the line *G, G₁*, while the secondary field would tend to cause the coil to indicate



Write for this book—

The famous Lynch 5-tube de luxe Deck. Simplifies home set-building at greatly reduced cost. This booklet describes the Lynch Complete Resistance Line.

Learn the Usefulness of "Resistance in Radio"

RADIO fans, set-builders, and engineers will find a wealth of reliable, boiled-down, and interesting information in "Resistance the 'Control Valve' of Radio." Simply written and clearly illustrated. Concisely presents the latest information on resistance coupled amplification, the function of resistance in a circuit, circuit arrangements on equalizers, and other radio matters of interest and importance. This valuable handbook on resistance in radio is worth dollars—you can get a copy for only 25 cents.

ARTHUR H. LYNCH, Inc.

1775 Broadway at 57th Street
General Motors Building, New York, N. Y.
Sales Offices in most large cities

Mr. Arthur H. Lynch,
1775 Broadway,
New York City

Dear Mr. Lynch:

Please send me a copy of your new booklet "Resistance the 'Control Valve' of Radio." I am enclosing 25 cents.

Name.....

Street.....

City.....State.....

R

Tell them that you saw it in RADIO

The New TEMPLE



Air Column SPEAKER

Here is the speaker that has startled radio fans from one end of the country to the other. It is a development of the air column principle of tone reproduction. Acknowledged by leading speaker engineers to be the only method of accurately transmitting sound.

Amazing Volume

People are amazed when they hear the Temple in comparison with the old type cone and other speakers which seemed fairly good a few months ago. But today is a new era in tone reproduction and Temple, thru this long air column principle, has given the entire radio world a new appreciation of radio.

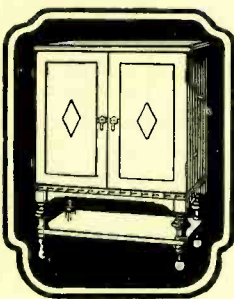

Tone Quality

When you have heard the Temple speaker, you will agree with all others who have heard it that its clearness of tone, its volume and its depth surpass anything you ever dreamed was possible.

Priced at \$29.00 up

TEMPLE, INC.
1925 South Western Ave.
CHICAGO

a direction along the line GB , pointing to the axis of the secondary conductor. As a consequence, the coil would give a resultant direction such as is shown by the heavy line GP . Similarly, at M , I , V , and J , other resultant directions would be obtained, all of which if plotted to scale as shown by the heavy line, would furnish a very good picture of the location of the axis of the secondary conductor B .

These principles of re-radiation and of coil action when correctly applied furnish the basis of this process as applied to the location of ore bodies. The only requirements are that the ore body being sought must be conductive to high frequency electrical current, and that it must be of reasonable length, the minimum length being dependent somewhat upon the depth. By using this process, it will be possible to determine the location of conductive ore bodies, both as to length and depth. Electro-conductive ore bodies include practically all of the sulphide ores and some ores found in a native state. Ores occurring in a disseminated state are amenable to the process as well as those occurring in a massive condition. It is not possible to determine the character of the ore body located, no distinction being possible between iron, copper, lead or other sulphides. Nor will this process determine the width or the thickness of the ore body located. On the other hand, it will determine the location of all electro-conductive ore bodies down to depths of approximately 500 ft. in the area to which it is applied, regardless of the over-burden which may be present. No contact to a known ore body in the vicinity is necessary. It can readily be seen that the application of the process to territories covered with over-burden such as lava cap, or float, or where no ore out-crops occur, offers immense possibility in disclosing unknown mineralized areas.

With the use of this process, there should accompany as a follow-up, the application of core or diamond drilling, in order that an inexpensive determination of the character of the ore body, of its value, and of its width and thickness may be obtained.

It is apparent that the means and methods now available are far from perfect, and that this field of experimentation offers great opportunities to the man who is technically trained in radio. Radio electrical surveying is in no sense destined to render the professional mining engineer and geologist of minor importance in the mining world. On the contrary, the mining engineer and the man specially trained in radio prospecting will work hand in hand in the future, so as to accurately locate valuable ores by scientific means solely and the haphazard and chance methods employed in the past will be obviated.

ABC Powerizer

*makes every
set a De Luxe
electric ~*

**Alternating current flows
uninterruptedly into new
A.C. Radiotrons in set ~
Finest tone quality in radio**

NOW you can have any radio set powerized— all ready to plug into light socket. No batteries, jellies, trickle charger eliminator units. Alternating current direct to A.C. Radiotrons in set is the only practical scientific method of electrification.

Deep bass notes— vibrant chords of the organ—are reproduced with the richness and mellowness achieved only by powerized amplification.

Write for literature explaining details of real A B C socket-power and tone quality.

RADIO RECEPTOR CO., Inc.
106 Seventh Ave., New York, N. Y.

LICENSED BY RADIO CORPORATION OF AMERICA AND ASSOCIATED COMPANIES

Atwater Kent Model—List without tubes \$60.00. Radiotrons UX-280 and UX-210, \$14.00.

Universal Model—for majority of 6-tube RFL and Neutrodyne circuits. Without tubes \$60.00. Radiotrons UX-280 and UX-210, \$14.00.

Radiola "20" Model—List without tubes \$59.00. Radiotrons UX-280 and UX-210, \$14.00.



AUTOMATIC RADIO CONTROL

(Continued from page 36)

a piece of No. 18 copper wire bent into a hook as shown. The brush proper is made by winding about 30 turns of No. 40 wire around nails spaced $\frac{3}{8}$ in. apart, after which one end of it is squeezed between the parallel sides of the hook and soldered. This assembly is soldered to the hour hand at such a point that from the center of the hour hand shaft to the end of the brush is $1\frac{7}{8}$ in. Several stationary contacts are made as required, the one in Fig. 4 being of "two hours length," i.e., having a length corresponding to the movement of the hour hand in two hours. One hour contacts are provided with but one lug. The lugs are used to fasten the contactors in place around the master contact ring and are held under knurled battery nuts screwed on the contact ring studs.

Both the concave sides of the stationary contacts and the hour-hand brush are amalgamated with mercury to give positive contact. This is accomplished by wiping the parts with a little sulphuric acid on a rag and then rubbing mercury on the surfaces. Too much acid should not be used on the brush or it will "eat up" the fine wires. Considerable mercury should be applied to the surfaces to give them a liquid metallic character. (Not more than a drop the size of a pea will be required.)



In the Still of the Arctic Night

In the still of the Arctic night, broken only by the occasional bark of a far-off walrus, the Radio Operator cannot leave his ship, frozen into the ice pack, and run around the corner to the Radio Shack for a new filter condenser to replace the one that just blew out.

He has got to be sure when he

starts that his equipment is not going to give out.

That is why Cliff Himoe took TOBE Condensers with him on the Bowdoin for the MacMillan Arctic Expedition.

Here is a Radio message just received from the boat: The TOBE'S are up to the mark!

"Your filter condenser standing up well on Bowdoin's transmitter, with no signs of trouble at continuous 2000 volts d.c. Regards from the Arctic."

HIMOE NWP

The University-of-Michigan-Greenland Expedition is also equipped with TOBE Condensers. Make sure that your Radio Power Equipment includes TOBE Condensers. TOBE Condensers cure condenser worries permanently and painlessly.

Send for price list P-1

Tobe Deutschmann Company

Cambridge

Massachusetts

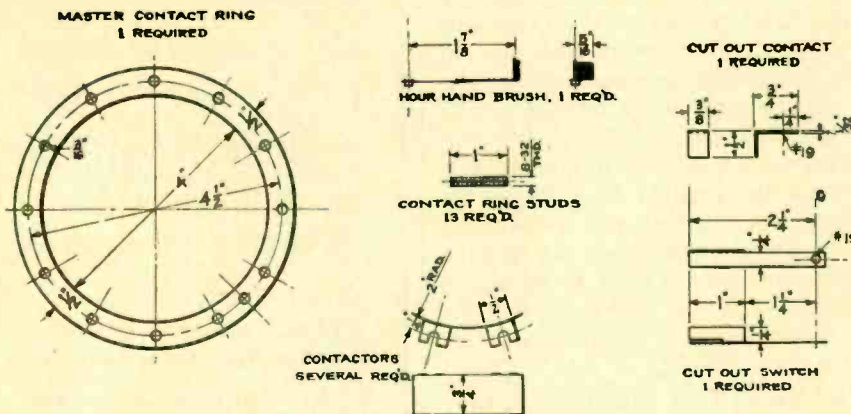

Fig. 4. Details of Metal Parts.

The cut-out switch should be of spring brass, approximately $\frac{1}{32}$ in. in thickness so that it will bear strongly against the cutout contact and give good contact.

All parts being constructed, assembly is next in order. The end pieces are first screwed to the front piece. The alarm clock is fastened to the columns by means of 8-32 bolts and nuts passing through the central holes of the columns and the elongated holes in the clock case. The cutout switch and contact are mounted on one column in such a manner that when the alarm mechanism operates the revolving key (with which it is wound) will push the switch off the contact and thus open the circuit. The switch is connected electrical-

Tested and Matched Tubes

OF COURSE, your set will work 25% better, as a general rule, if all the tubes are precisely matched and hand-picked for best characteristics as to radio frequency amplification, detection, oscillation and audio stages. In the laboratory of "RADIO" magazine we have a complete tube testing device for accurately doing this work. We make no extra charge for hand-picking and matching tubes. Any type of tube can be supplied. Several days' time must be allowed for testing, packing and shipping.

Laboratory of "Radio"

435 Pacific Building
San Francisco California

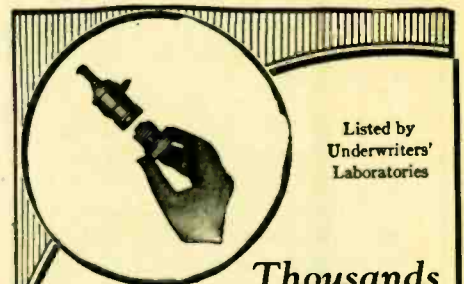

Listed by
Underwriters'
Laboratories

Thousands
Are Using This

ELECTRAD

Lamp Socket
Antenna
\$1.00

Every electrical outlet in your home is an aerial if you use this Lamp Socket Antenna. Screws in like any light bulb. Consumes no current. Positively safe. Very neat in design and made with genuine Bakelite. Tested at 2500 volts A. C.

At your dealer's or write

Dept. 57B, 175 Varick St., New York

ELECTRAD

Tell them that you saw it in RADIO

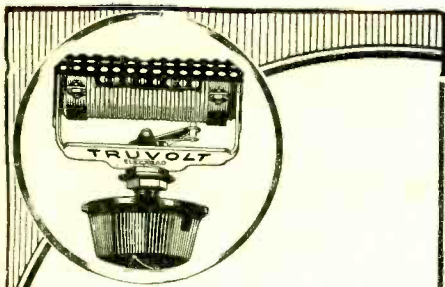

*Constant
Accuracy!*

TRUVOLT

*An All-Wire
Variable
Voltage Control*

Install Truvolt in the B-Eliminator you are constructing and vary your voltage exactly. A new type wire variable high resistance kept cool by its greater radiation surface—like an air-cooled motor.

Develops but 1/2 the temperature of other resistances of like size; hence is permanently accurate and lasts indefinitely. Positive metallic contact always and 30 exact readings of resistances.

Type	Resistance (Ohms)	Current (Milliamperes)
T-5	0 to 500	224
T-10	0 to 1,000	158
T-20	0 to 2,000	112
T-50	0 to 5,000	71
T-100	0 to 10,000	50
T-200	0 to 20,000	35
T-250	0 to 25,000	32
T-500	0 to 50,000	22.5

Price \$3.50 each

All rated at 25 watts.

AT YOUR DEALERS

*Also a full line of
Wire Fixed Resistances*

Write for free hook-up circular

Dept. 16B, 175 Varick St., New York

"This is an Eliminator Year"

ELECTRAD

ly to the clock case and held to the column by an 8-32 bolt 1 in. long which passes through case, column, and sufficient washers or a spacing piece to raise the switch 1/4 in. from the column. The contact is insulated from the case, being held by an 8-32 bolt passing through the column at right angles to the one just considered. This contact forms the second external connection of the unit.

The columns are then screwed in place between the end pieces and the clock adjusted to a central location in the 4-in. hole. The hour and minute hands are pressed on, the latter being bent up so as to pass the hour-hand brush, and the stationary contactors placed around the master contact ring as desired. Final adjustment of the brush is made, care taken to see that it presses against the contactors with a fairly good pressure since experiment has shown this can be quite large without slowing down the clock. Finally, the shorting switch is connected across the master contact ring and the cut-out contact, and the wiring of the unit in the A circuit accomplished as shown in Fig. 2.

To test the unit put the filament switch normally included in the receiver to the on position, close the cutout switch and set the clock until the hour-hand is on a contactor. The filaments should light as long as the brush and contactor are in contact and go out when they are not in contact; the shorting switch being in the off position, of course. Now set off the alarm, thus opening the cutout switch, and the filaments should not light regardless of the position of the hour hand. Finally, put the shorting switch to the on position and the tubes should light, being lighted or extinguished now by the regular filament switch just as if the automatic control was not present.

This makes your radio outfit a truly automatic affair, requiring attention but once in the morning instead of twice every time you listen to a program. The automatic control requires practically no attention, other than a little new mercury on the contacts every month or so to keep them bright, and will amply repay the constructor by the pride that will be his in possessing such an uncanny radio.

YOUR NEXT "B" Power Supply

had Better be the
NATIONAL BETTER "B"

Type 7180

NATIONAL CO., Inc.

W. A. Ready, Pres.

Malden, Mass.

Tell them that you saw it in RADIO



Live

Where uptown and
downtown meet

That's what everyone would like to do—combine country quiet with Broadway activities.

And that's exactly what this hotel offers you.

The serenity of Central Park; where two of New York's most desirable thoroughfares meet, Central Park West and 72nd Street, —and yet just 10 minutes from leading shops and theatres.

Appointments, service, cuisine unexcelled, in keeping with its international reputation.

Booklet sent free on request
on New York and Hotel Majestic

Opeland Townsend

Proprietor

Majestic Hotel and RESTAURANTS

Two W. 72nd St., New York

Entire Block Fronting Central Park

General Headquarters:

New York Automobile Club

The Majestic Hotel, Central Park West
at 72nd Street, New York City.

Without obligating me, please send me free
Booklet on New York and Hotel Majestic.

Name.....

Address.....

Radio 11-27

At \$6.00 this famous
Cabinet
has no equal!

The Blue Ridge
7"x18"x10" Mahogany
or Walnut Finish

Send us your order or
write for catalog and
full information. 12
hour service, factory
to you.

Southern Toy Co. Inc.
MANUFACTURERS HICKORY N.C.

RADIOADS

8 8 8

A Classified Advertising Section Read by Better Buyers.

8 8 8

The rate per word is eight cents net. Remittance must accompany all advertisements. Include name and address when counting words.

8 8 8

Ads for the February Issue Must Reach Us by January Fifth

Have U LOG-CHARTED UR RADIO with the latest. Only a DOT locates each station. Absolutely no writing. 25c. DeaRie Radio Laboratories, 505 Madison Square Bldg., Chicago, Illinois.

PRESS AND PUBLIC concede it to be the best ever produced. "Radio Theory and Operating" by Mary Texanna Loomis, member Institute of Radio Engineers, lecturer on theory of radio, Loomis Radio College. Thorough text and reference book; 886 pages, 700 illustrations, handsome, flexible binding. Price \$3.50, postage paid. Used by Radio Schools, Technical Colleges, Universities, Government Schools. Department of Commerce and Engineers. At bookdealers, or sent on receipt of check or money order to Loomis Publishing Company, Dept. X, 405 9th St., Washington, D. C.

AVERAGE INTELLIGENCE plus our home training places you in a big paying radio job. Information upon request. McKay Instrument Co., 631 Railway Exchange Bldg., Portland, Ore.

DO YOU GET TIRED of buying "B" batteries? A lifetime Edison will solve your troubles. Good, live, large size elements connected with pure nickel wire, electrically welded. 7c pair. All parts for sale. Sample cell and dope sheet, 10c. Paul Mills, Woodburn, Oregon.

REMLER-BEST 1925 SUPER. With matched tubes and American-de-luxe audio transformers. Set has just been matched and rewired by McGown and is working perfectly. First money order for \$110.00 takes it. Coalinga Electric & Music Co., Coalinga, Calif.

VICTOREEN SUPERHET. Set of transformers at a bargain. Radio, 3836 East 15th St., Long Beach, Calif.

MUST SELL—\$250.00 ware 7 tube Neutrodyne, shielded, single control. \$100.00; 5 tube radio frequency, \$20.00; Radiola Loud Speaker, \$9.00; Radiola Loop, \$5.00; Homecharger, \$9.00; Brand new Singer electric sewing machine, portable, cost \$100.00, sell for \$59.00. All guaranteed in perfect working order. Include postage. B. Fox, 887 Longwood Ave., Bronx, New York.

FOR SALE—Sargent-Raymont Infradyne, 1927 Model, good as new. Write for full details and bargain price. Bob H. Elliott, Conyers, Georgia.

THORDARSON Push-Pull power amplifier with latest Thordarson transformer, chokes and Potter extra heavy duty condenser block. Has two push-pull Thordarson audio transformers. Mounted on wood baseboard and partially wired. All parts guaranteed in perfect condition and used only few weeks. Parts cost new \$65.00. Will sell whole works for \$38.00. First money order takes it. Write to Box 100, "RADIO" Magazine, Pacific Building, San Francisco.

BARGAIN—One completely assembled Balsa Speaker, equipped with Western Electric Driving Unit. \$18.00. G. M. Best, 1460 Grand Ave., Piedmont, Calif.

LAST YEAR'S INFRADYNE. Thorola coils and Cardwell 3 gang condenser but has no audio amplifier. Parts and fine cabinet cost \$130.00. Must be rewired. Owner has left for me to sell to first person sending \$40, plus express charges. D. B. McGown, 435 Pacific Building, San Francisco, Calif.

RADIO GENERATORS 500, 900 cycles A. C., sizes from ¼ K.W. to 5 K.W. Alternators, with or without external motors, at attractive prices. 900 cycle self excited alternators \$20.00 each. Others equally low priced. Direct current machines bought and sold. D. B. McGown, 435 Pacific Building, San Francisco, Calif.

NINE-IN-LINE SUPER, with General Radio Audio Transformers. Fine set and efficient. NEED MONEY. First check for \$65.00 takes it. Cost over \$165 for parts, and wiring. H. Feldbusch, 1227 47th Avenue, San Francisco, Calif.

THREE WESTERN ELECTRIC SUPER-HETERODYNE transformers \$20.00. Few peanut tubes \$2.25. Levy, 2050 69th St., Brooklyn, N. Y.

Nathaniel
BALDWIN
LOUD SPEAKERS

A Famous Speaker

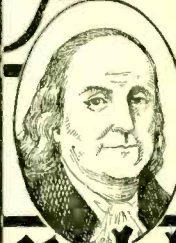

Benj. Franklin once said. "My performance devotes itself entirely to thy service & will serve thee faithfully and if it has the good fortune to please its master, tis gratification enough for the labor of—"Poor Richard"

The New "99"

Baldwin 99

is without comparison. To-day, as 15 years ago, Baldwin performance is the standard by which others are judged. The workmanship of this speaker is comparable to the sensitive mechanism of a fine watch. Can be used on any set.

Write for booklet.

At all good **\$28.50** dealers

Ask your dealer to demonstrate it.

BALDWIN UNITS
Loudspeaker units, Phono adapters, and head sets are standard the world over.

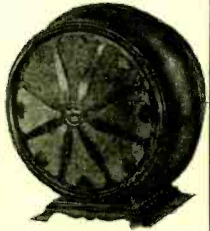

J. W. & W. L. WOLF
Distributors & Exporters
227-229 Fulton St., N. Y.

*In Canada Baldwin International, Ltd.
Toronto*



Exclusively Licensed by Technidyne Corporation under U. S. Patent No. 1593658, July 27, 1926

Every Man Needs

TONATROL

A True Tone and Volume Control

No more fussing to secure just the right volume. With "Tonatrol" you can get it instantly—from the softest lullaby music to the most powerful tones.

"Tonatrol" is a welcome addition to any receiver. Made of genuine bakelite. Very easy to install.

Tonatrol—Standard Volume Control	\$1.50
Tonatrol—Type W. S. (with filament switch attached)	\$2.00

Write for free installation booklet for the correct way to control volume.

Dept. 54C, 175 Varick St., New York

ELECTRAD

A HOMEY HOTEL IN THE HEART OF NEW YORK

THE *New Flanders*

47th to 48th STREET EAST OF BROADWAY

One of the finest Hotels in TIMES SQUARE

Single Rooms with Running Water,	\$2.00
Double Rooms with Running Water,	\$3.00
Single Rooms with Bath	\$2.50
Double Rooms with Bath	\$3.50

Special Weekly Rates
F. W. BIZEL, Resident Manager



Tell them that you saw it in RADIO

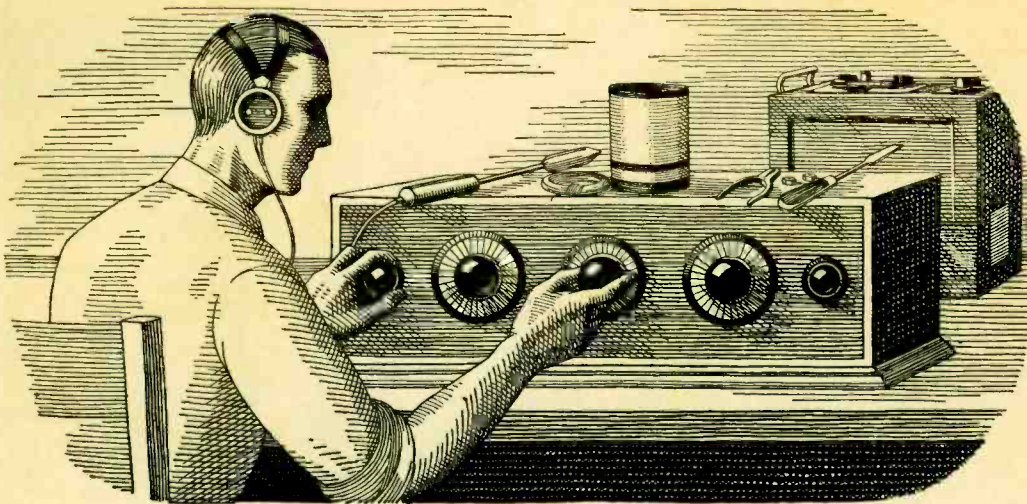

If all the Radio sets I've "fooled" with in my time were piled on top of each other, they'd reach about halfway to Mars. The trouble with me was that I thought I knew so much about Radio that I really didn't know the first thing. I thought Radio was a plaything—that was all I could see in it for me.

I Thought Radio Was a Plaything

But Now My Eyes Are Opened, And I'm Making Over \$100 a Week!

\$50 a week! Man alive, just one year ago a salary that big would have been the height of my ambition.

Twelve months ago I was scrimping along on starvation wages, just barely making both ends meet. It was the same old story—a little job, a salary just as small as the job—while I myself had been dragging along in the rut so long I couldn't see over the sides.

If you'd told me a year ago that in twelve months' time I would be making \$100 and more every week in the Radio business—whew! I know I'd have thought you were crazy. But that's the sort of money I'm pulling down right now—and in the future I expect even more. Why only today—

But I'm getting ahead of my story. I was hard up a year ago because I was kidding myself, that's all—not because I had to be. I could have been holding then the same sort of job I'm holding now, if I'd only been wise to myself. If you've fooled around with Radio, but never thought of it as a serious business, maybe you're in just the same boat I was. If so, you'll want to read how my eyes were opened for me.

When broadcasting first became the rage, several years ago, I first began my dabbling with the new art of Radio. I was "nuts" about the subject, like many thousands of other fellows all over the country. And no wonder! There's a fascination—something that grabs hold of a fellow—about twirling a little knob and suddenly listening to a voice speaking a thousand miles away! Twirling it a little more and listening to the mysterious dots and dashes of steamers far at sea. Even today I get a thrill from this strange force. In those days, many times I stayed up almost the whole night trying for DX. Many times I missed supper because I couldn't be dragged away from the latest circuit I was trying out.

I never seemed to get very far with it, though. I used to read the Radio magazines and occasionally a Radio book, but I never understood what the subject very clearly, and lots of things I didn't see through at all.

So, up to a year ago, I was just a dabbler—I thought Radio was a plaything. I never realized what an enormous, fast growing industry Radio had come to be—employing thousands and thousands of trained men.

I usually stayed home in the evenings after work, because I didn't make enough money to go out very much. And generally during the evening I'd tinker a little with Radio—a set of my own or some friend's. I even made a little spare change this way, which helped a lot, but I didn't know enough to go very far with such work.

And as for the idea that a splendid Radio job might be mine, if I made a little effort to prepare for it—such an idea never entered my mind. When a friend suggested it to me one year ago, I laughed at him.

"You're kidding me," I said.

"I'm not," he replied. "Take a look at this ad."

He pointed to a page ad in a magazine, an advertisement I'd seen many times but just passed up without thinking, never dreaming it applied to me. This time I read the ad carefully. It told of many big opportunities for trained men to succeed in the great new Radio field. With the advertisement was a coupon offering a big free book full of information. I sent the coupon in, and in a few days received a handsome 64-page book, printed in two colors, telling all about the opportunities in the Radio field and how a man can prepare quickly and easily at home to take advantage of these opportunities. Well, it was a revelation to me. I read the book carefully, and when I finished it I made my decision.

What's happened in the twelve months since that day, as I've already told you, seems almost like a dream to me now. For ten of those twelve months, I've had a Radio business of my own. At first, of course, I started it as a little proposition on the side, under the guidance of the National Radio Institute, the outfit that gave me my Radio training. It wasn't long before I was getting so much to do in the Radio line that I quit my measly little clerical job, and devoted my full time to my Radio business.

Since that time I've gone right on up, always under the watchful guidance of my friends at the National Radio Institute. They would have given me just as much help, too, if I had wanted to follow some other line of Radio besides building my own retail business—such as broadcasting, manufacturing, experimenting, sea operating, or any one

of the score of lines they prepare you for. And to think that until that day I sent for their eye-opening book, I'd been wailing "I never had a chance!"

Now I'm making, as I told you before, over \$100 a week. And I know the future holds even more, for Radio is one of the most progressive, fastest-growing businesses in the world today. And it's work that I like—work a man can get interested in.

Here's a real tip. You may not be as bad off as I was. But think it over—are you satisfied? Are you making enough money, at work that you like? Would you sign a contract to stay where you are now for the next ten years—making the same money? If not, you'd better be doing something about it instead of drifting.

This new Radio game is a live-wire field of golden rewards. The work, in any of the 20 different lines of Radio, is fascinating, absorbing, well paid. The National Radio Institute—oldest and largest Radio home-study school in the world—will train you inexpensively in your own home to know Radio from A to Z and to increase your earnings in the Radio field.

Take another tip—No matter what your plans are, no matter how much or how little you know about Radio—clip the coupon below and look their free book over. It is filled with interesting facts, figures, and photos, and the information it will give you is worth a few minutes of anybody's time. You will place yourself under no obligation—the book is free, and is gladly sent to anyone who wants to know about Radio. Just address J. E. Smith, President, National Radio Institute, Dept. IR, Washington, D. C.

**J. E. SMITH, President,
National Radio Institute,
Dept. MB-5, Washington, D. C.**

Dear Mr. Smith:

Please send me your 64-page free book, printed in two colors, giving all information about the opportunities in Radio and how I can learn quickly and easily at home to take advantage of them. I understand this request places me under no obligation, and that no salesman will call on me.

Name.....

Address.....

Town..... State.....

Complete Light Socket Operation With Your Present Set

BY MEANS of the parts shown here, and the new Alternating Current Tubes, your present set can be converted for complete socket operation at small expense. There is no necessity of scrapping your present set.

Your Community set builder knows how—if you do not care to undertake the conversion of your receiver for socket operation, go to your Community set builder—he is prepared to serve you.

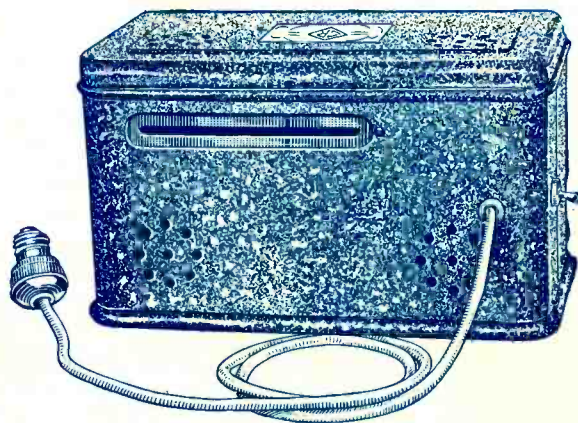

Type 445
Plate Supply And Grid Bias

Furnishes four "B" voltages and "C" bias voltage for power tube. Three "B" voltages are adjustable from 0-180. "C" bias adjustable 0-50. Licensed by R. C. A.—Price \$55.00 without tube.



Type 439
Center Tap
Resistance

Furnishes the center tap required by A. C. Tubes. Price 60 cents.

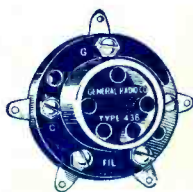

Type 438
Five Prong
Socket

For the 227 type tube. Price 50c.



Type 440A
Low Voltage
Transformer

Supplies all filament voltages required by A. C. Tubes. Price \$10.00.

GENERAL RADIO CO.

30 State Street



Cambridge, Mass.

HERE IT IS!

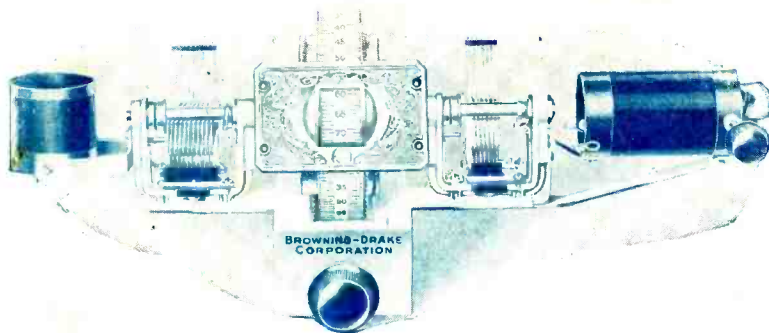

The New Official **BROWNING-DRAKE KIT**

BETTER than ever, the new Browning-Drake Kit, pictured above, carries forward the Browning-Drake tradition of fine and efficient radio apparatus. Electrical design, incorporating the famous slot-wound primary developed by Messrs. Browning and Drake, is enhanced by an advanced mechanical assembly. Now it is even easier to build a fine, dependable radio receiver using this new Browning-Drake Kit. A new and efficient type of small coil is used in the new Kit. A single-control illuminated drum dial is operated by a knob below a beautiful escut-

cheon plate. Two precision-built condensers are driven by the drum dial which develops no backlash whatever. This Kit comes mounted as a single unit and may be easily mounted against the front panel.

Radio engineers who have seen this new Kit pronounce it one of the finest pieces of radio apparatus that has yet appeared.

New constructional booklets describing the new Official Five Tube assembly and special Two Tube Tuner for Thordarson or other specified power amplifiers, may be secured from your dealer or direct for 25c.

BROWNING-DRAKE CORPORATION
Cambridge Mass.

Genuine BROWNING-
Bears This



DRAKE Apparatus
Trade Mark

Look For It!

BROWNING PARTS DRAKE KITS